

Hood upper part

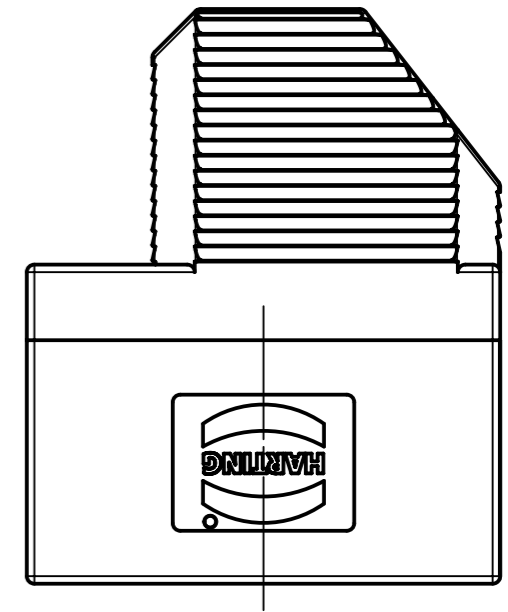

Hood lower part

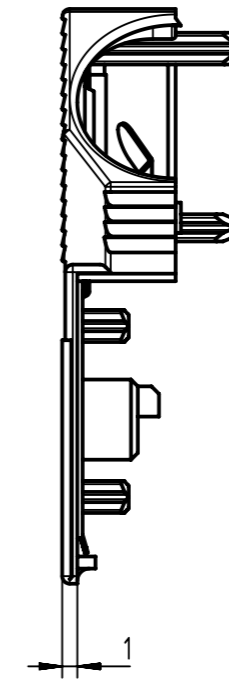
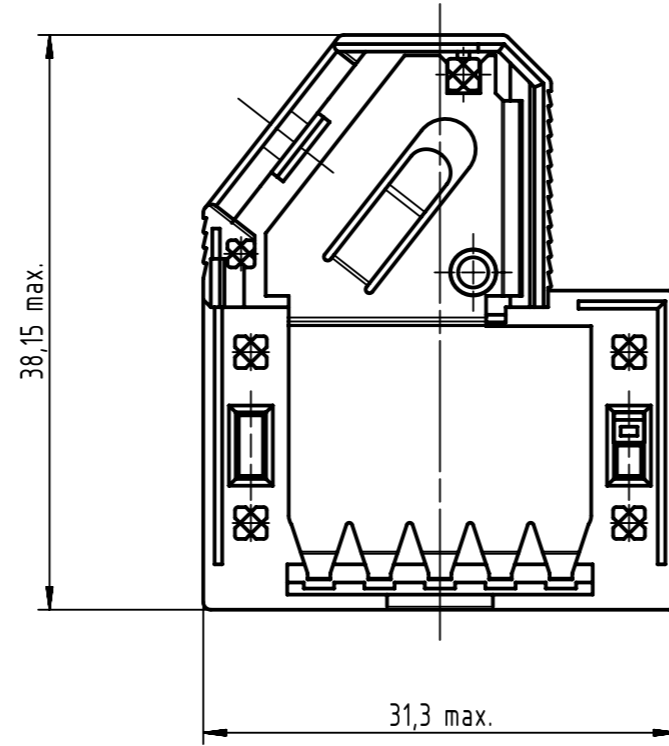
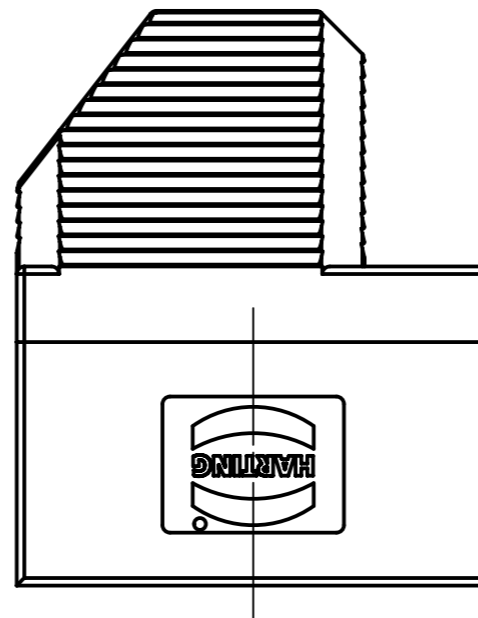
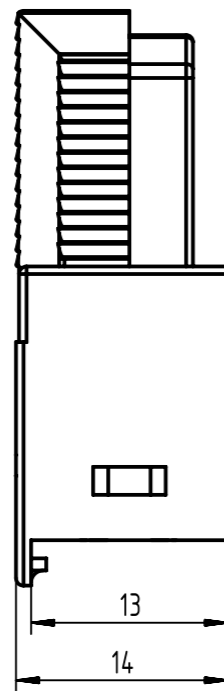
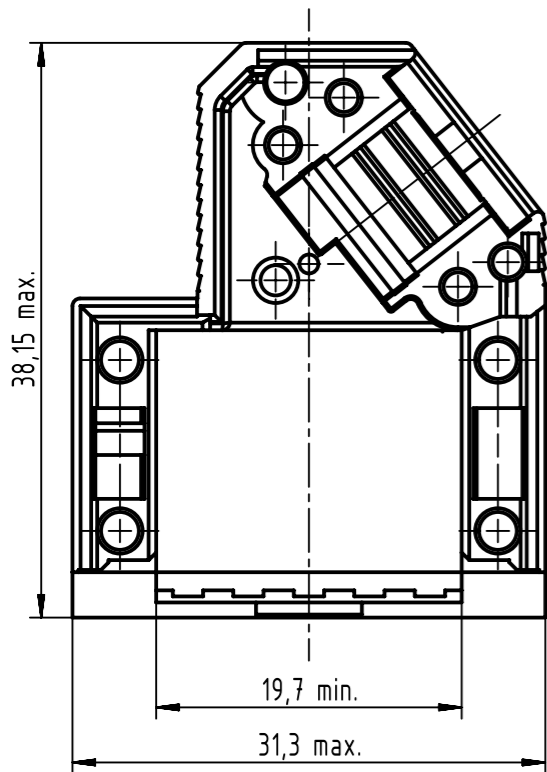

Strain relief 1

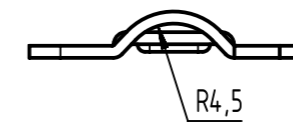
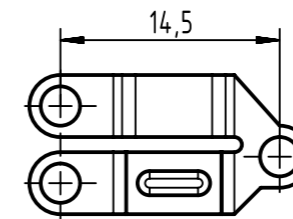

Strain relief 2

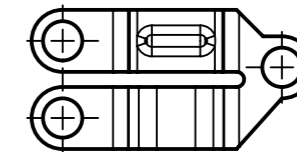
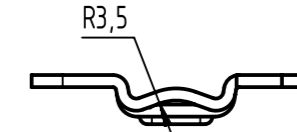

Flashed screw

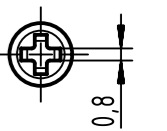
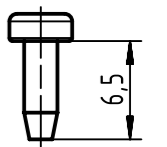

	All rights reserved	Created by	Inspected by	Standardisation	Date	State
	Department EC PD - CN	ZHUANGJ	LUOK	KOHLER	2017-08-04	Final Release
All Dimensions in mm Original Size DIN A3		Scale	Free size tol.		Ref.	
		2:1			Sub.	
HARTING Electronics GmbH D-32339 Espelkamp		Title D-Sub 9-pole shielding hood assembly			Doc-Key / ECM-Nr. 100228763/UGD/002/B 500000123273	
		Type	Number		Rev.	Page
		TB	09670090573		B	1/1

0967 009 0573 210	2sets into one polybag , 20sets in one box
0967 009 0573	Standard packing in tray
Part number	Packing information