

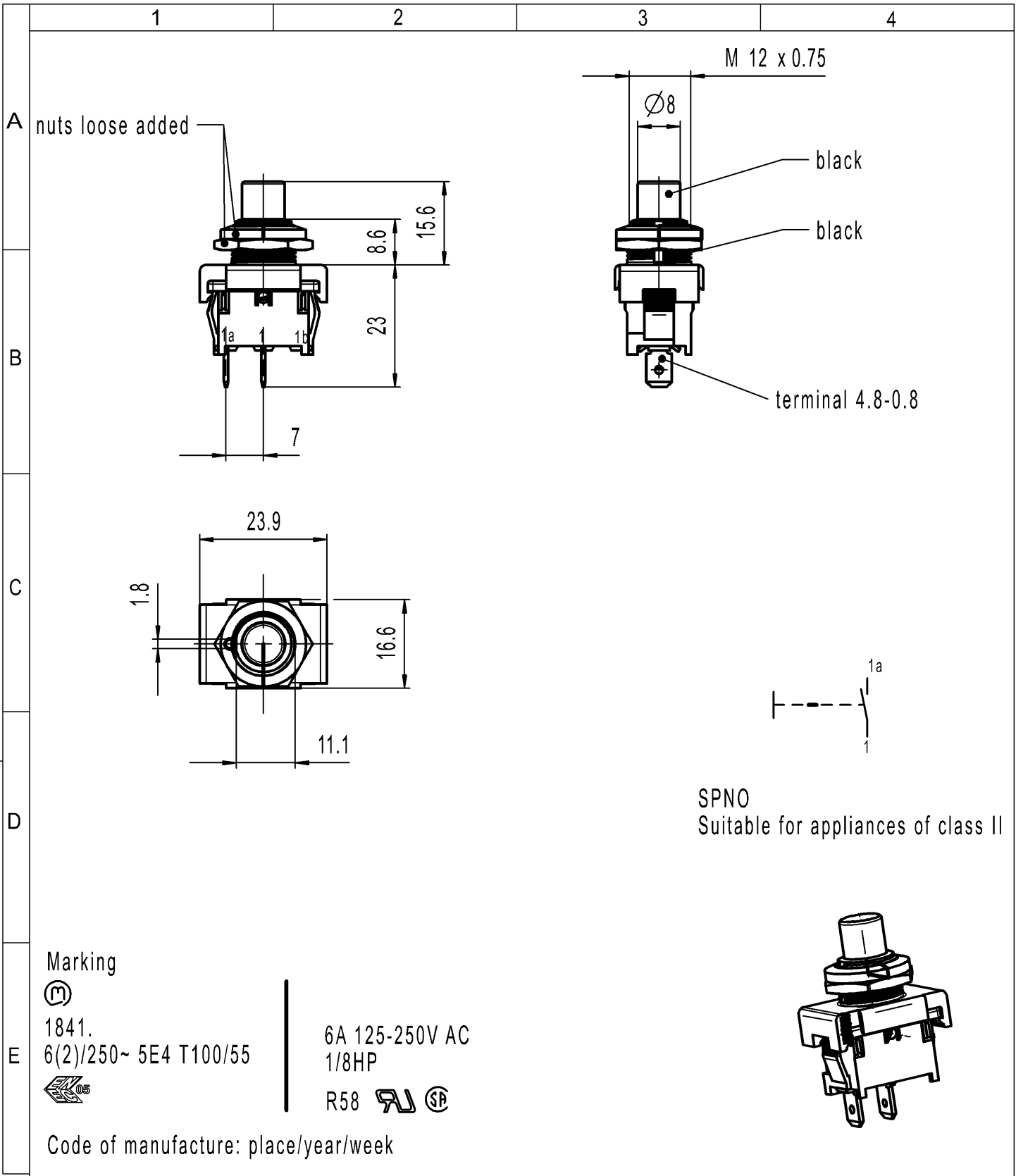



CONFIDENTIAL

VERTRAULICH

THIS DRAWING IS THE EXCLUSIVE PROPERTY OF MARQUARDT. WITHOUT THEIR CONSENT IT MAY NOT BE REPRODUCED OR GIVEN TO THIRD PARTIES.



Alle Rechte bei Marquardt, auch fuer den Fall von Schutzrechtsanmeldungen. Jede Veruegungsbefugnis, wie Kopier- und Weitergaberecht, bei uns.

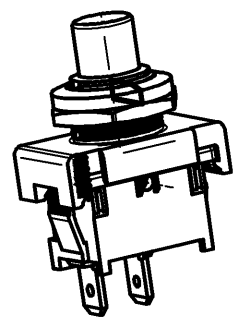

Marking

 1841.
 6(2)/250~ 5E4 T100/55
 | 6A 125-250V AC
 1/8HP
 R58  

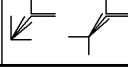
Code of manufacture: place/year/week



-		-		-		1841.1201-XX				
Figure		Type		Customer No.		Art.No.-PI				
General tolerances				Sheet 01			Ident. K	Document number 18411201	Index f	
All dimensions are in millimetres	Shape and location 	Angle $\pm 2^\circ$	Edge tolerance 	Length	Radii	Format DIN A4	Projection 	Scale 1:1	Appliance Switch	
				0-6	± 0.2					\pm
				>6-15	± 0.4					\pm
				>15-30	± 0.4					\pm
				>30-70	\pm					\pm
>70-120	\pm	\pm								
>120	\pm	\pm								
f	131663	2020-08-26	THAKARES			System NX V11.0				
e	64533	2010-04-13	MUT							
d	56042	2008-01-21	VOR			Replacement of Zg.gl.Nr.v.30.08.2000				
c	29876	2000-06-19	BMI							
Index	MEC-No.	Date (YYYY-MM-DD)	Edited by			 MARQUARDT				