

FOR USE WITH AWG 12, 14 AND 16

FOR USE WITH CABLE TYPE:
PLTC, PLTC-ER, ITC, ITC-ER, MC, MV AND TC

FOR USE IN CLASS I, DIVISION 2 GROUPS A, B, C AND D
HAZARDOUS LOCATIONS OR UNCLASSIFIED LOCATIONS

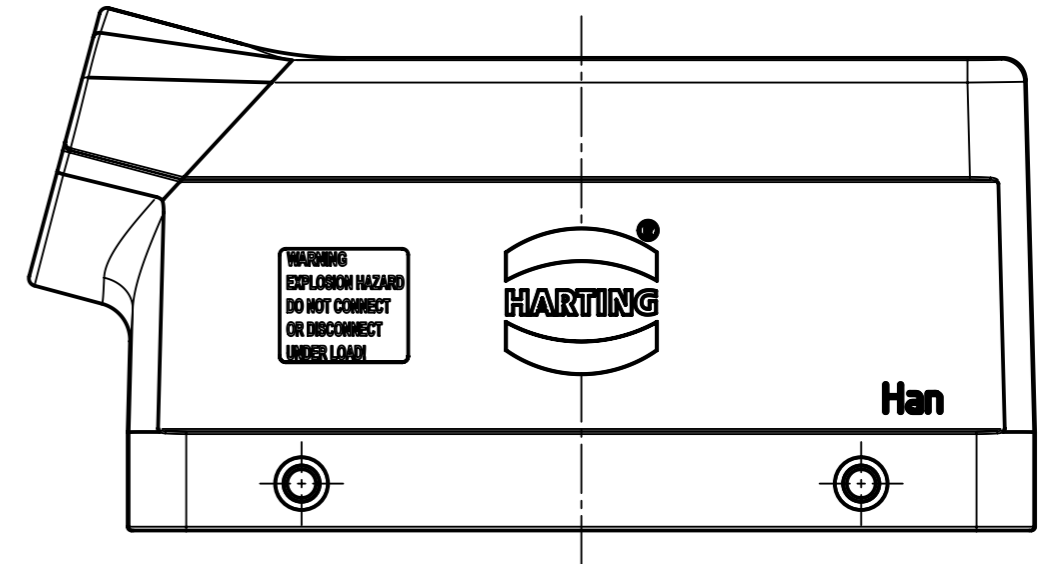
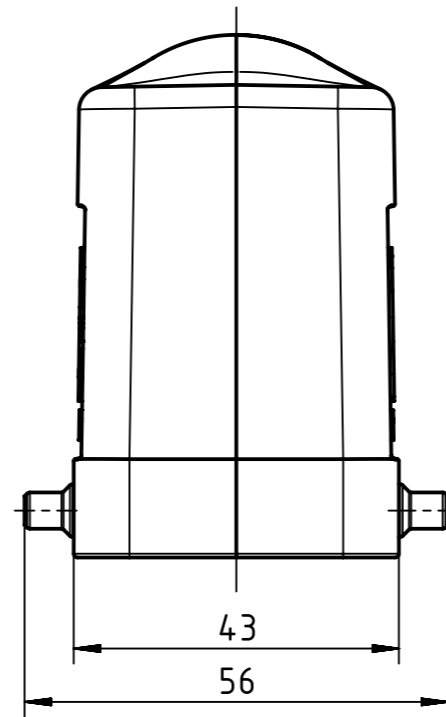
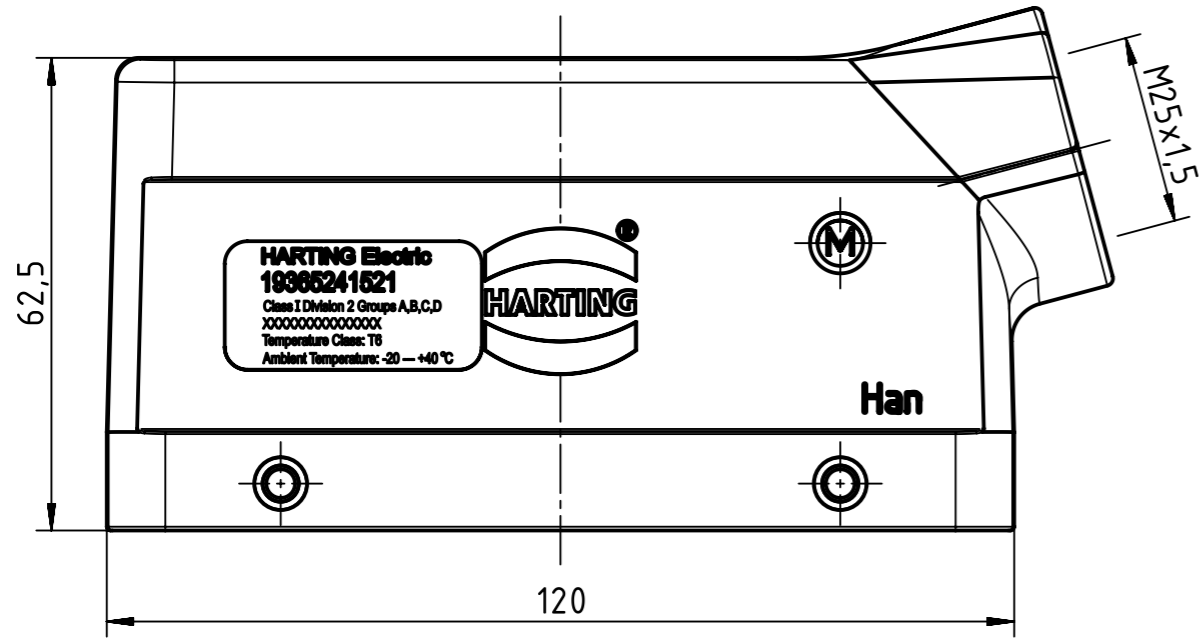
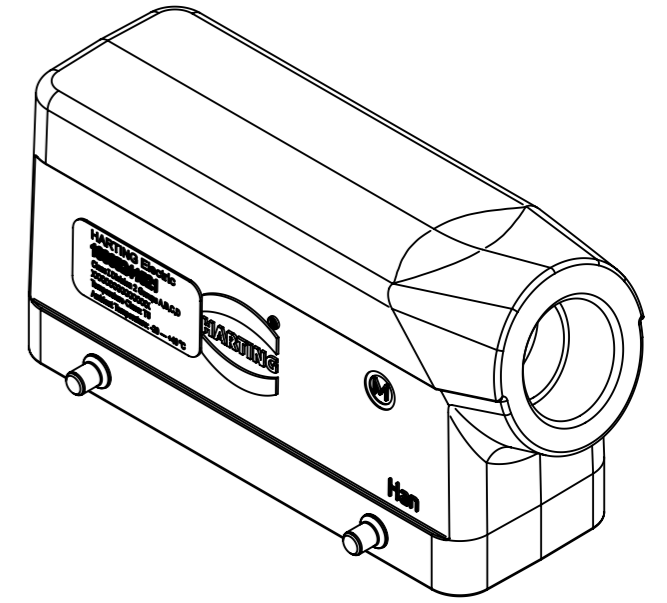

WARNING
EXPLOSION HAZARD
DO NOT CONNECT
OR DISCONNECT
UNDER LOAD!

THE INSTALLATION MUST BE IN ACCORDANCE WITH THE ASSOCIATED LOCATION RESTRICTIONS OF THE NATIONAL ELECTRIC CODE OR CANADIAN ELECTRICAL CODE AS APPLICABLE, INCLUDING ISSUES SUCH AS THE ROUTING, SUPPORT AND LENGTH OF THE INVOLVED CORD OR CABLE.

	All rights reserved Department EL PD	All Dimensions in mm Original Size DIN A3		Scale 1:1	Free size tol.	Ref.
		Created by LONGL	Inspected by WENE	Standardisation RUETERA	Date 2018-06-27	State Final Release
HARTING (Zhuhai) Manufacturing Co., Ltd. 519085 Zhuhai, China		Title Han 24Ex UL-HSE-M25			Doc-Key / ECM-Nr. 100670281/UGD/000/C 500000136860	
		Type TB	Number 19 36 524 1521		Rev. C	Page 1/2

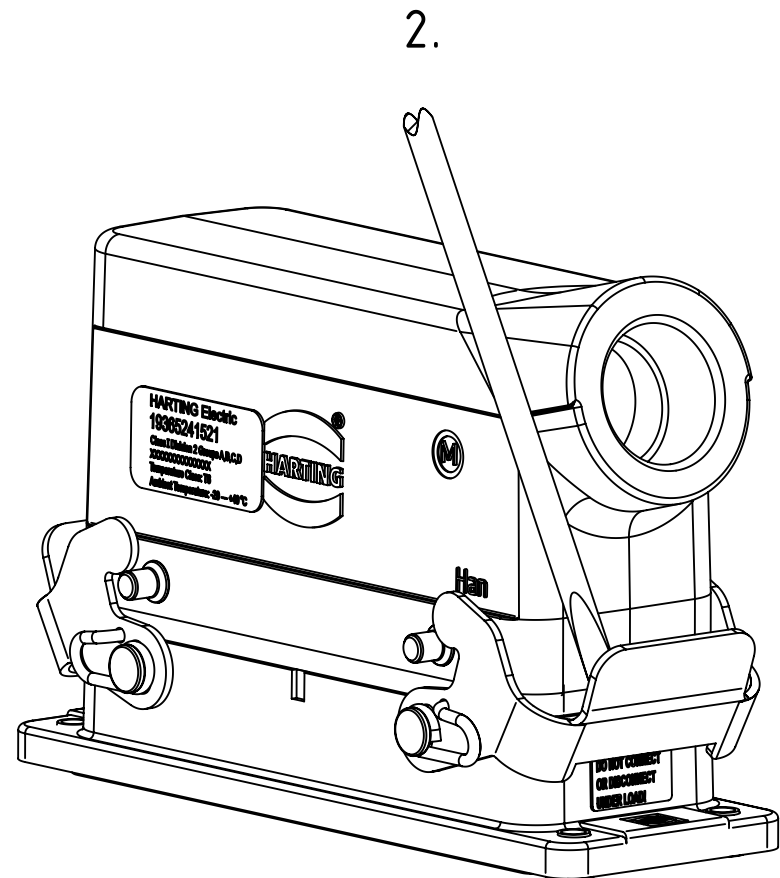
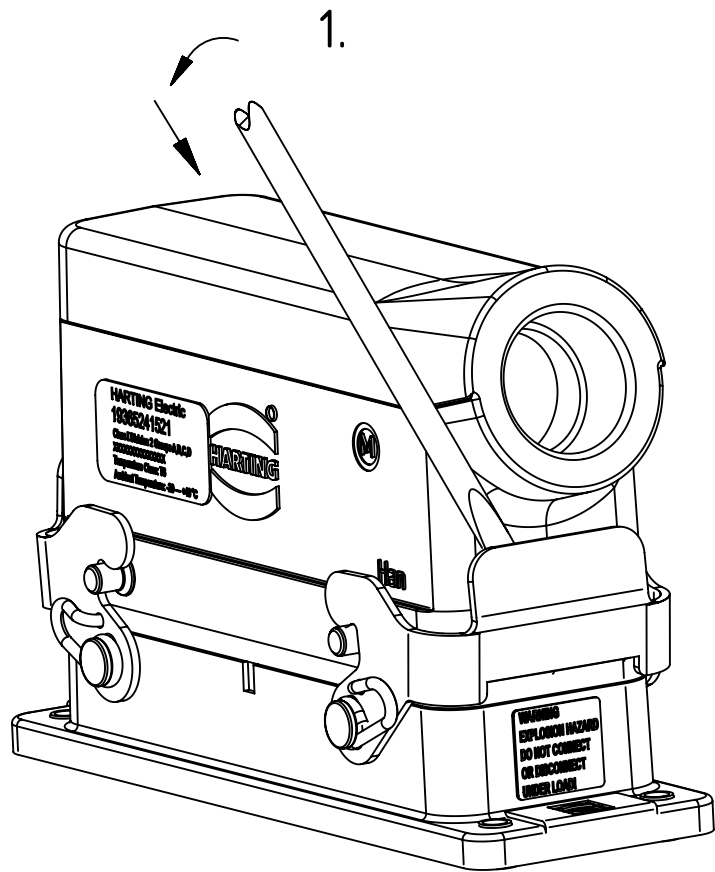

To separate connectors, insert small flat head tool or screwdriver between metal lever and housing as shown in the diagram,. Press screwdriver in a downward direction until the metal lever releases.

To secure the hood and housing assembly together, press the metal levers in the upward direction until metal lever latches into housing pins.