

Durchführungen / Winkelstecker

Bulkhead Connectors / Plugs Angled



A D F ■ ■ ■ ■ ■ ■ ■ ■ ■ ■ 00 0151 ■ ■ ■ ■

A vernickelt nickel-plated

Durchführung

mit Überwurfmutter M23 x 1, Flanschbefestigung 25 x 25 mm, axiale O-Ring Abdichtung

Bulkhead Connector

with coupling nut M23 x 1, flange mount 25 x 25 mm, axial o-ring seal

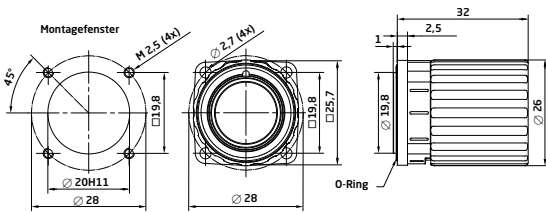

SpeedTec QUICK LOCKING SYSTEM

A D F ■ ■ ■ ■ ■ ■ ■ ■ ■ ■ 00 0101 ■ ■ ■ ■

A vernickelt nickel-plated

Durchführung

mit SpeedTec Schnellverschluss, Flanschbefestigung 25 x 25 mm, axiale O-Ring Abdichtung

Bulkhead Connector

with SpeedTec quick lock fastener, flange mount 25 x 25 mm, axial o-ring seal

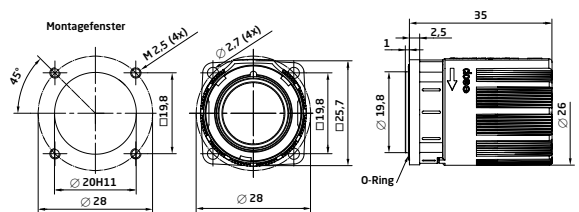

A S D ■ ■ ■ ■ ■ ■ ■ ■ ■ ■ 0150 ■ ■ ■ ■

A vernickelt nickel-plated

Winkelstecker drehbar

mit Überwurfmutter M23 x 1

Plug Angled rotatable

with coupling nut M23 x 1

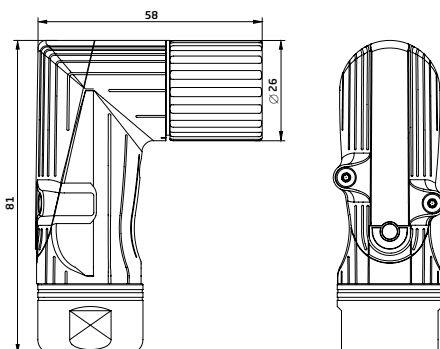

SpeedTec QUICK LOCKING SYSTEM

A S D ■ ■ ■ ■ ■ ■ ■ ■ ■ ■ 0100 ■ ■ ■ ■

A vernickelt nickel-plated

Winkelstecker drehbar

mit SpeedTec Schnellverschluss

Plug Angled rotatable

with SpeedTec quick lock fastener

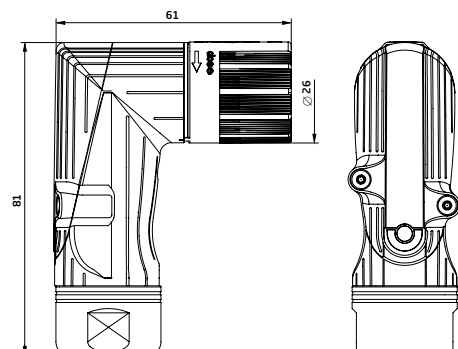

Isolierkörper und Kontakte

Insulation Inserts and Contacts



6-polig P
(6 x Ø 2 mm)
6-pin P

0° codiert 0° coded

Ansicht steckseitig
mating view

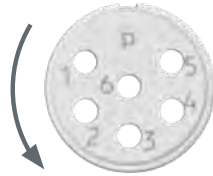

7-polig P
(7 x Ø 2 mm)
7-pin P

0° codiert 0° coded

Ansicht steckseitig
mating view

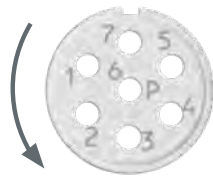

6-polig E
(6 x Ø 2 mm)
6-pin E

0° codiert 0° coded

Ansicht steckseitig
mating view

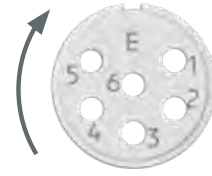

7-polig E
(7 x Ø 2 mm)
7-pin E

0° codiert 0° coded

Ansicht steckseitig
mating view

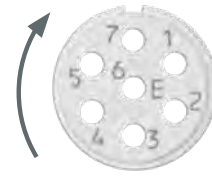

Kontaktbuchse Ø 2 mm **Contact Socket Ø 2 mm**
Nicht im Lieferumfang enthalten Not part of product contents



Ø 2 mm
geschlitzt, Crimpbereich 0,35 - 2,5 mm²
slotted, crimping range 0.35 - 2.5 mm²

60.012.11



Ø 2 mm
geschlitzt, Lötkehl 2,5 mm²
slotted, solder bucket 2.5 mm²

60.014.11



Kontaktstift Ø 2 mm **Contact Pin Ø 2 mm**
Nicht im Lieferumfang enthalten Not part of product contents



Ø 2 mm
Crimpbereich 0,35 - 2,5 mm²
crimping range 0.35 - 2.5 mm²

61.008.11



Ø 2 mm
Lötkehl 2,5 mm²
solder bucket 2.5 mm²

61.011.11

Art.-Nr. Art. No.



9-polig P
(9 x Ø 1 mm)
9-pin P

uncodiert uncodet

Ansicht steckseitig
mating view

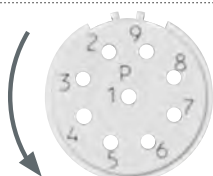

9-polig E
(9 x Ø 1 mm)
9-pin E

uncodiert uncodet

Ansicht steckseitig
mating view

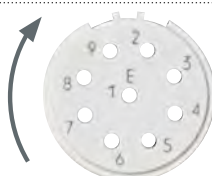

Kontaktbuchse Ø 1 mm **Contact Socket Ø 1 mm**
Nicht im Lieferumfang enthalten Not part of product contents



Ø 1 mm
Drahtfeder, Crimpbereich 0,14 - 1,0 mm²
wire spring, crimping range 0.14 - 1.0 mm²

60.001.11



Ø 1 mm
geschlitzt, Crimpbereich 0,14 - 1,0 mm²
slotted, crimping range 0.14 - 1.0 mm²

60.011.11



Ø 1 mm
Drahtfeder, Lötkehl 1,5 mm²
wire spring, solder bucket 1.5 mm²

60.004.11



Kontaktstift Ø 1 mm **Contact Pin Ø 1 mm**
Nicht im Lieferumfang enthalten Not part of product contents



Ø 1 mm
geschlitzt, Lötkehl 1,5 mm²
slotted, solder bucket 1.5 mm²

60.013.11



Ø 1 mm
geschlitzt, Crimpbereich 0,03 - 0,34 mm²
slotted, crimping range 0.03 - 0.34 mm²

60.172.11

Art.-Nr. Art. No.



Kontaktstift Ø 1 mm **Contact Pin Ø 1 mm**
Nicht im Lieferumfang enthalten Not part of product contents



Ø 1 mm
Crimpbereich 0,14 - 1,0 mm²
crimping range 0.14 - 1.0 mm²

61.004.11



Ø 1 mm
Lötkehl 1,5 mm²
solder bucket 1.5 mm²

61.006.11



Ø 1 mm
Crimpbereich 0,03 - 0,34 mm²
crimping range 0.03 - 0.34 mm²

61.083.11

Art.-Nr. Art. No.

Isolierkörper und Kontakte



8+1-polig P
(8 x Ø 1 mm + 1 x Ø 2 mm)
8+1-pin P

uncodiert uncoded

Ansicht steckseitig
mating view

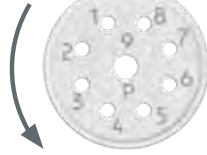

Kontaktbuchse Ø 1 mm **Contact Socket Ø 1 mm**
Nicht im Lieferumfang enthalten Not part of product contents



Ø 1 mm
Drahtfeder, Crimpbereich 0,14 - 1,0 mm²
wire spring, crimping range 0.14 - 1.0 mm²



Ø 1 mm
geschlitzt, Crimpbereich 0,14 - 1,0 mm²
slotted, crimping range 0.14 - 1.0 mm²



Ø 1 mm
Drahtfeder, Lötkelch 1,5 mm²
wire spring, solder bucket 1.5 mm²



Ø 1 mm
geschlitzt, Lötkelch 1,5 mm²
slotted, solder bucket 1.5 mm²



Ø 1 mm
geschlitzt, Crimpbereich 0,03 - 0,34 mm²
slotted, crimping range 0.03 - 0.34 mm²

Art.-Nr. Art. No. **60.001.11**

60.011.11

60.004.11

60.013.11

60.172.11



Kontaktbuchse Ø 2 mm **Contact Socket Ø 2 mm**
Nicht im Lieferumfang enthalten Not part of product contents



Ø 2 mm
geschlitzt, Crimpbereich 0,35 - 2,5 mm²
slotted, crimping range 0.35 - 2.5 mm²



Ø 2 mm
geschlitzt, Lötkelch 2,5 mm²
slotted, solder bucket 2.5 mm²

Art.-Nr. Art. No. **60.012.11**

60.014.11



Kontaktstift Ø 1 mm **Contact Pin Ø 1 mm**
Nicht im Lieferumfang enthalten Not part of product contents



Ø 1 mm
Crimpbereich 0,14 - 1,0 mm²
crimping range 0.14 - 1.0 mm²



Ø 1 mm
Lötkelch 1,5 mm²
solder bucket 1.5 mm²



Ø 1 mm
Crimpbereich 0,03 - 0,34 mm²
crimping range 0.03 - 0.34 mm²

Art.-Nr. Art. No. **61.004.11**

61.006.11

61.083.11



Kontaktstift Ø 2 mm **Contact Pin Ø 2 mm**
Nicht im Lieferumfang enthalten Not part of product contents



Ø 2 mm
Crimpbereich 0,35 - 2,5 mm²
crimping range 0.35 - 2.5 mm²



Ø 2 mm
Lötkelch 2,5 mm²
solder bucket 2.5 mm²

Art.-Nr. Art. No. **61.008.11**

61.011.11

Isolierkörper und Kontakte

Insulation Inserts and Contacts



12-polig P
(12 x Ø 1 mm)
12-pin P

0° codiert 0° coded

Ansicht steckseitig
mating view

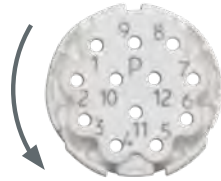

12-polig E
(12 x Ø 1 mm)
12-pin E

0° codiert 0° coded

Ansicht steckseitig
mating view

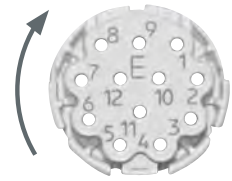

17-polig P
(17 x Ø 1 mm)
17-pin P

0° codiert 0° coded

Ansicht steckseitig
mating view

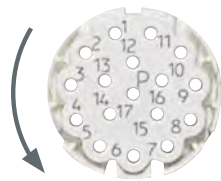

17-polig E
(17 x Ø 1 mm)
17-pin E

0° codiert 0° coded

Ansicht steckseitig
mating view

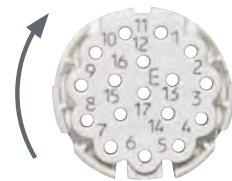

Kontaktbuchse Ø 1 mm **Contact Socket Ø 1 mm**
Nicht im Lieferumfang enthalten Not part of product contents



Ø 1 mm
Drahtfeder, Crimpbereich 0.14 - 1.0 mm²
wire spring, crimping range 0.14 - 1.0 mm²
60.001.11



Ø 1 mm
geschlitzt, Crimpbereich 0.14 - 1.0 mm²
slotted, crimping range 0.14 - 1.0 mm²
60.011.11



Ø 1 mm
Drahtfeder, Lötkehl 1.5 mm²
wire spring, solder bucket 1.5 mm²
60.004.11



Ø 1 mm
geschlitzt, Lötkehl 1.5 mm²
slotted, solder bucket 1.5 mm²
60.013.11



Ø 1 mm
geschlitzt, Crimpbereich 0.03 - 0.34 mm²
slotted, crimping range 0.03 - 0.34 mm²
60.172.11

Art.-Nr. Art. No.



Kontaktstift Ø 1 mm **Contact Pin Ø 1 mm**
Nicht im Lieferumfang enthalten Not part of product contents



Ø 1 mm
Crimpbereich 0.14 - 1.0 mm²
crimping range 0.14 - 1.0 mm²
61.004.11



Ø 1 mm
Lötkehl 1.5 mm²
solder bucket 1.5 mm²
61.006.11



Ø 1 mm
Crimpbereich 0.03 - 0.34 mm²
crimping range 0.03 - 0.34 mm²
61.083.11

Art.-Nr. Art. No.



Bandkontaktbuchse Ø 1 mm **Bandoleer Contact Socket Ø 1 mm**
Nicht im Lieferumfang enthalten Not part of product contents



Ø 1 mm
Crimpgröße 1 (0.03 - 0.08 mm²)
7000 Stück auf Rolle
crimping size 1 (0.03 - 0.08 mm²)
7000 pcs on reel
60.198.80



Ø 1 mm
Crimpgröße 2 (0.08 - 0.20 mm²)
7000 Stück auf Rolle
crimping size 2 (0.08 - 0.20 mm²)
7000 pcs on reel
60.199.80



Ø 1 mm
Crimpgröße 3 (0.20 - 0.52 mm²)
7000 Stück auf Rolle
crimping size 3 (0.20 - 0.52 mm²)
7000 pcs on reel
60.200.80



Ø 1 mm
Crimpgröße 4 (0.75 - 1.0 mm²)
10000 Stück auf Rolle
crimping size 4 (0.75 - 1.0 mm²)
10000 pcs on reel
60.201.80

Art.-Nr. Art. No.



Bandkontaktstift Ø 1 mm **Bandoleer Contact Pin Ø 1 mm**
Nicht im Lieferumfang enthalten Not part of product contents



Ø 1 mm
Crimpgröße 1 (0.03 - 0.08 mm²)
7000 Stück auf Rolle
crimping size 1 (0.03 - 0.08 mm²)
7000 pcs on reel
61.170.80



Ø 1 mm
Crimpgröße 2 (0.08 - 0.20 mm²)
7000 Stück auf Rolle
crimping size 2 (0.08 - 0.20 mm²)
7000 pcs on reel
61.171.80



Ø 1 mm
Crimpgröße 3 (0.20 - 0.52 mm²)
7000 Stück auf Rolle
crimping size 3 (0.20 - 0.52 mm²)
7000 pcs on reel
61.172.80



Ø 1 mm
Crimpgröße 4 (0.75 - 1.0 mm²)
10000 Stück auf Rolle
crimping size 4 (0.75 - 1.0 mm²)
10000 pcs on reel
61.173.80

Art.-Nr. Art. No.

Isolierkörper und Kontakte

Insulation Inserts and Contacts



16+3-polig P
(16 x Ø 1 mm + 3 x Ø 1,5 mm)
16+3-pin P

0° codiert 0° coded

Ansicht steckseitig
mating view

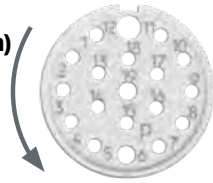

16+3-polig E
(16 x Ø 1 mm + 3 x Ø 1,5 mm)
16+3-pin E

0° codiert 0° coded

Ansicht steckseitig
mating view

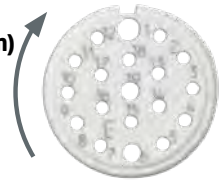

Kontaktbuchse Ø 1 mm **Contact Socket Ø 1 mm**
Nicht im Lieferumfang enthalten Not part of product contents



Ø 1 mm
Drahtfeder, Crimpbereich 0,14 - 1,0 mm²
wire spring, crimping range 0.14 - 1.0 mm²

Art.-Nr. Art. No. **60.001.11**



Ø 1 mm
geschlitzt, Crimpbereich 0,14 - 1,0 mm²
slotted, crimping range 0.14 - 1.0 mm²

60.011.11



Ø 1 mm
Drahtfeder, Lötkehl 1,5 mm²
wire spring, solder bucket 1.5 mm²

60.004.11



Ø 1 mm
geschlitzt, Lötkehl 1,5 mm²
slotted, solder bucket 1.5 mm²

60.013.11



Ø 1 mm
geschlitzt, Crimpbereich 0,03 - 0,34 mm²
slotted, crimping range 0.03 - 0.34 mm²

60.172.11



Kontaktbuchse Ø 1,5 mm **Contact Socket Ø 1.5 mm**
Nicht im Lieferumfang enthalten Not part of product contents



Ø 1,5 mm
geschlitzt, Crimpbereich 0,24 - 1,0 mm²
slotted, crimping range 0.24 - 1.0 mm²

Art.-Nr. Art. No. **60.070.11**



Ø 1,5 mm
geschlitzt, Lötkehl 1,5 mm²
slotted, solder bucket 1.5 mm²

60.173.11



Kontaktstift Ø 1 mm **Contact Pin Ø 1 mm**
Nicht im Lieferumfang enthalten Not part of product contents



Ø 1 mm
Crimpbereich 0,14 - 1,0 mm²
crimping range 0.14 - 1.0 mm²

Art.-Nr. Art. No. **61.004.11**



Ø 1 mm
Lötkehl 1,5 mm²
solder bucket 1.5 mm²

61.006.11



Ø 1 mm
Crimpbereich 0,03 - 0,34 mm²
crimping range 0.03 - 0.34 mm²

61.083.11



Kontaktstift Ø 1,5 mm **Contact Pin Ø 1.5 mm**
Nicht im Lieferumfang enthalten Not part of product contents



Ø 1,5 mm
Crimpbereich 0,24 - 1,0 mm²
crimping range 0.24 - 1.0 mm²

61.072.11



Ø 1,5 mm
Lötkehl 1,5 mm²
solder bucket 1.5 mm²

61.152.11



Bandkontaktbuchse Ø 1 mm **Bandleer Contact Socket Ø 1 mm**
Nicht im Lieferumfang enthalten Not part of product contents



Ø 1 mm
Crimprgröße 1 (0,03 - 0,08 mm²)
7000 Stück auf Rolle
crimping size 1 (0.03 - 0.08 mm²)
7000 pcs on reel

Art.-Nr. Art. No. **60.198.80**



Ø 1 mm
Crimprgröße 2 (0,08 - 0,20 mm²)
7000 Stück auf Rolle
crimping size 2 (0.08 - 0.20 mm²)
7000 pcs on reel

60.199.80



Ø 1 mm
Crimprgröße 3 (0,20 - 0,52 mm²)
7000 Stück auf Rolle
crimping size 3 (0.20 - 0.52 mm²)
7000 pcs on reel

60.200.80



Ø 1 mm
Crimprgröße 4 (0,75 - 1,0 mm²)
10000 Stück auf Rolle
crimping size 4 (0.75 - 1.0 mm²)
10000 pcs on reel

60.201.80



Bandkontaktstift Ø 1 mm **Bandleer Contact Pin Ø 1 mm**
Nicht im Lieferumfang enthalten Not part of product contents



Ø 1 mm
Crimprgröße 1 (0,03 - 0,08 mm²)
7000 Stück auf Rolle
crimping size 1 (0.03 - 0.08 mm²)
7000 pcs on reel

Art.-Nr. Art. No. **61.170.80**



Ø 1 mm
Crimprgröße 2 (0,08 - 0,20 mm²)
7000 Stück auf Rolle
crimping size 2 (0.08 - 0.20 mm²)
7000 pcs on reel

61.171.80



Ø 1 mm
Crimprgröße 3 (0,20 - 0,52 mm²)
7000 Stück auf Rolle
crimping size 3 (0.20 - 0.52 mm²)
7000 pcs on reel

61.172.80



Ø 1 mm
Crimprgröße 4 (0,75 - 1,0 mm²)
10000 Stück auf Rolle
crimping size 4 (0.75 - 1.0 mm²)
10000 pcs on reel

61.173.80

Werte nach VDE 0110/EN 61984, Abschnitt 6.19.2.2

Verschmutzungsgrad	3
Überspannungskategorie	III
Maximale Aufstellhöhe	2000 m

Individuelle VDE Zertifizierungen und Zulassungen sind auf Anfrage möglich.

Values according to VDE 0110/EN 61984, part 6.19.2.2

pollution degree	3
over voltage category	III
max. height for operation	2000 m

Individual VDE certifications and accreditations available on request.

Allgemeine technische Daten

Kontaktanschlusarten

Crimpausführung, Lötkegel, einlöt

Temperaturbereich

-20° C bis 130° C / optional ab -50°C

Schutzart

gesteckt IP 66/67

Schirmung

EMV - Gehäuseschirmung

Steckzyklen

min. 500

Kabelklemmbereich

Ø 3,5 - Ø 14,7 mm

Verriegelungsarten

Schraub M23 x 1; Schnellverschluss SpeedTec

General Technical Data

Contact Terminations

crimp version, solder cup, solder-in

Temperature Range

-20° C to 130° C / optional from -50°C

Protection Type

IP 66/67 when connected

Shielding

EMC shielded housing

Mating Cycles

min. 500

Clamping Range









Ø 3.5 - Ø 14.7 mm

Locking Types

threaded version M23 x 1; quick lock system SpeedTec

Elektrische Daten

Electrical Data

		Bemessungsstrom bei max. Anschlussquerschnitt rated current at max. connection cross section	Bemessungsspannung rated voltage	Bemessungsstossspannung (L-L) rated insulation voltage	Polzahl number of pins	Kontakt Ø contact Ø	Max. Anschlussquerschnitt max. cross section
		[A]	[V]	[kV]		[mm]	[mm²]
6		20	32	1,5	6	2	2,5
7		20	32	1,5	7	2	2,5
9 (8+1)		10	160	2,5	9 (8+1)	1/2	1/2,5
9		10	160	2,5	9	1	1
10		9	125	4,0	10	1	1
12		7	160	2,5	12	1	1
17		7	125	2,0	17	1	1
19 (16+3)		7	63	1,5	19 (16+3)	1/1,5	1/1,5
TWINTEC-B		7	63	2,0	19 (14 + PE + 4)	1	1