



Winkelstecker/-dose nach MIL C-5015 Serie CVS | Fabrikat Van-System

Polzahlen: siehe u.g. Übersicht

Anzahl Baugrößen: 12

Schutzart: IP 67 (in verriegeltem Zustand und bei exakt angepasstem Kabel)

Anschlussart: Löten (Crimpen auf Anfrage)

Verriegelung: Schraubverriegelung

Betriebstemperatur: -55 °C bis +125 °C

Material Gehäuse: Aluminium, chemisch vernickelt, leitfähig, einteilig, silbern

Material Kontakträger: Gummi, eingepresst (Kodierung auf Anfrage)

Material Kontakte: Kupfer, versilbert

Geeignet für Kabeldurchmesser: abhängig von gewählter Kabelverschraubung

Kabelzugentlastung: mittels Kabelverschraubung (separat zu bestellen - siehe evg.de / Shop / Gehäuse/Verschraubungen)

Lieferumfang: Schraubadapter, metrisch / Pg (bitte auswählen - siehe folgende Seiten)

Zubehör: Schutzkappe CVS 042-xx F5 (siehe Datenblatt)

Hinweis: Polbilder und elektrische Daten (siehe folgende Seiten)



Übersicht Polzahlen - verfügbare Baugrößen

Polzahl	Baugrößen	Polzahl	Baugrößen
1	16, 18, 20, 22, 28	22	28, 32, 36
2	10SL, 14S, 16S, 16, 18, 20, 22, 24, 32	23	32
3	10SL, 14S, 16S, 16, 18, 20, 22, 24, 28, 32, 36	24	22, 24
4	14S, 16, 18, 20, 22, 24, 32, 36	25	24, 32
5	14S, 16S, 16, 18, 22, 24, 28, 32	26	28
6	14S, 18, 20, 22, 24, 28, 36	28	24
7	14S, 16S, 18, 20, 22, 24, 28, 36	30	32
8	18, 20, 22, 24, 28, 32	31	28, 32, 36
9	20, 22, 24, 28, 32	34	32
10	16, 18, 22, 24, 28, 36	35	28, 32, 36
11	20, 24	37	28
12	24, 28	39	36
13	20, 32	42	32
14	20, 22, 28, 36	47	36
15	28	48	32, 36
16	24, 28, 32	54	32
17	20, 32	55	24, 32
19	20, 22, 24, 32	56	36
20	28	72	28

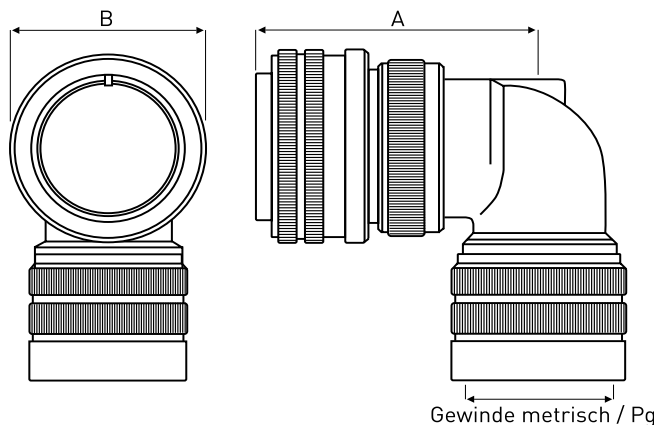

Baugröße	Rundsteckverbinder nach MIL C-5015		Abmessungen mm	
	Winkelstecker	Winkeldose	A	B
10SL	CVS 08DA 10SL-XX P YYY F5	CVS 08DA 10SL-XX S YYY F5	45,5	22,8
14S	CVS 08DA 14S-XX P YYY F5	CVS 08DA 14S-XX S YYY F5	45,5	28,5
16S	CVS 08DA 16S-XX P YYY F5	CVS 08DA 16S-XX S YYY F5	47,0	31,8
16	CVS 08DA 16-XX P YYY F5	CVS 08DA 16-XX S YYY F5	56,5	31,8
18	CVS 08DA 18-XX P YYY F5	CVS 08DA 18-XX S YYY F5	57,5	34,0
20	CVS 08DA 20-XX P YYY F5	CVS 08DA 20-XX S YYY F5	60,0	37,3
22	CVS 08DA 22-XX P YYY F5	CVS 08DA 22-XX S YYY F5	62,5	40,5
24	CVS 08DA 24-XX P YYY F5	CVS 08DA 24-XX S YYY F5	65,5	43,5
28	CVS 08DA 28-XX P YYY F5	CVS 08DA 28-XX S YYY F5	65,5	50,0
32	CVS 08DA 32-XX P YYY F5	CVS 08DA 32-XX S YYY F5	70,0	56,1
36	CVS 08DA 36-XX P YYY F5	CVS 08DA 36-XX S YYY F5	73,5	62,5
40	auf Anfrage	auf Anfrage	78,5	69,1

Bitte Bestellnummer vervollständigen: XX-XX = Code für Polbild | YYY = Code für Schraubadapter (siehe folgende Seiten)







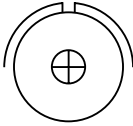
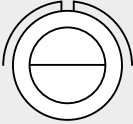
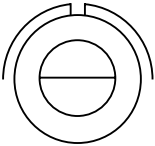
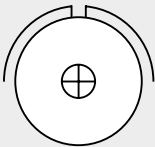
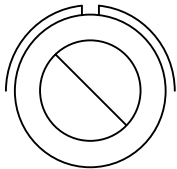
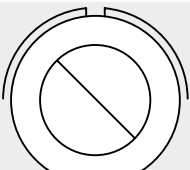
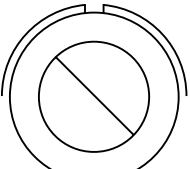
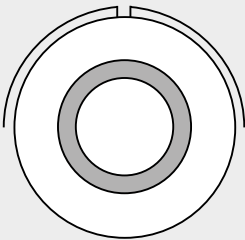

Schutzart IP 67 | Schirmbar (EMV-Verschraubung notwendig)

Polbilder / Baugrößen / elektrische Daten



Polzahl 1

Polzahl	Baugröße	Code XX-XX für Polbild	Code YYY für Schraubadapter		Polbild (Steckseite Stift)	Größe Kontakt	für AWG	Strombelastung A	Spannung max. DC / AC V
			metrisch	Pg					
1	16	16-2	M16	PG11 PG13,5 PG16		12	12	23	1.750 / 1.250
1	16	16-12	M16	PG11 PG13,5 PG16		4	4	80	700 / 500
1	18	18-6	M25	PG13,5 PG21		4	4	80	1.250 / 900
1	18	18-16	M25	PG13,5 PG21		12	12	23	4.200 / 3.000
1	20	20-2	M16 M20 M32	PG13,5 PG16 PG21 PG29		0	0	150	1.250 / 900
1	22	22-7	M16 M20 M32	PG13,5 PG16 PG29		0	0	150	1.750 / 1.250
1	22	22A1	M16 M20 M32	PG13,5 PG16 PG29		0	0	150	750
1	28	28A1	M20 M25 M40	PG29 PG36		4/0	4/0	225	750

Polbilder / Baugrößen / elektrische Daten Polzahl 2

Polzahl	Baugröße	Code XX-XX für Polbild	Code YYY für Schraubadapter		Polbild (Steckseite Stift)	Größe Kontakt	für AWG	Strombelastung A	Spannung max. DC / AC V
			metrisch	Pg					
2	10SL	10SL-4	M12 M20	PG7 PG11 PG16		16	18-16	13	700 / 500
2	14S	14S-9	M12 M20	PG7 PG11 PG16		16	18-16	13	700 / 500
2	16S	16S-4	M16	PG11 PG13,5 PG16		16	18-16	13	1.250 / 900
2	16	16-11	M16	PG11 PG13,5 PG16		12	12	23	700 / 500
2	18	18-3	M25	PG13,5 PG21		12	12	23	1.250 / 900
2	18	18-14	M25	PG13,5 PG21		1x 4 1x 16	4 18-16	80 13	700 / 500
2	20	20-23	M16 M20 M32	PG13,5 PG16 PG21 PG29		8	8	46	700 / 500
2	22	22-1	M16 M20 M32	PG13,5 PG16 PG29		8	8	46	1.250 / 900
2	22	22-8	M16 M20 M32	PG13,5 PG16 PG29		12	12	23	1.750 / 1.250

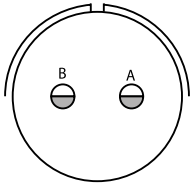
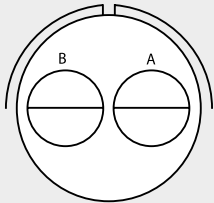
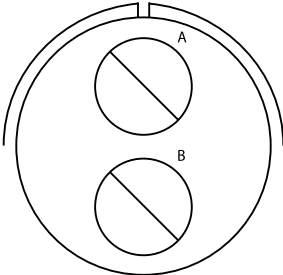
Polbilder / Baugrößen / elektrische Daten Polzahlen 2-3

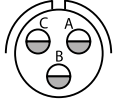
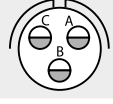
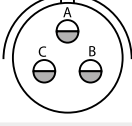
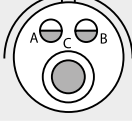
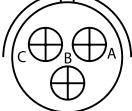
Polzahl	Baugröße	Code XX-XX für Polbild	Code YYY für Schraubadapter		Polbild (Steckseite Stift)	Größe Kontakt	für AWG	Strombelastung A	Spannung max. DC / AC V
			metrisch	Pg					
2	22	22-11	M16 M20 M32	PG13,5 PG16 PG29		16	18-16	13	2.450 / 1.750
2	24	24-9	M20 M25 M40	PG13,5 PG16 PG29		4	4	80	700 / 500
2	32	32-5	M25 M32 M40	PG21 PG29 PG36		0	0	150	1.250 / 900
3	10SL	10SL-3	M12 M20	PG7 PG11 PG16		16	18-16	13	700 / 500
3	14S	14S-1	M12 M20	PG7 PG11 PG16		16	18-16	13	700 / 500
3	14S	14S-7	M12 M20	PG7 PG11 PG16		16	18-16	13	700 / 500
3	16S	16S-5	M16	PG11 PG13,5 PG16		16	18-16	13	700 / 500
3	16	16-7	M16	PG11 PG13,5 PG16		1x 8 2x 16	8 18-16	46 13	700 / 500
3	16	16-10	M16	PG11 PG13,5 PG16		12	12	23	700 / 500

Polbilder / Baugrößen / elektrische Daten Polzahl 3

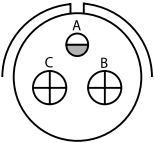
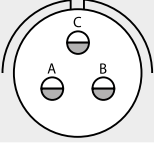
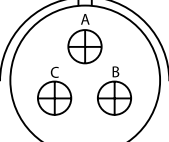
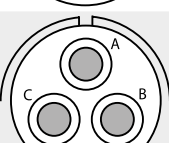
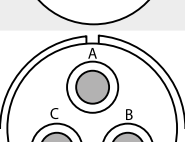
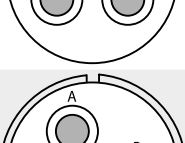
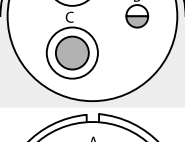
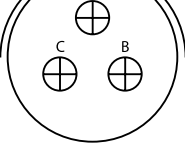
Polzahl	Baugröße	Code XX-XX für Polbild	Code YYY für Schraubadapter		Polbild (Steckseite Stift)	Größe Kontakt	für AWG	Strombelastung A	Spannung max. DC / AC V
			metrisch	Pg					
3	18	18-5	M25	PG13,5 PG21		2x 12 1x 16	12 18-16	23 13	1.250 / 900
3	18	18-22	M25	PG13,5 PG21		16	18-16	13	1.250 / 900
3	20	20-3	M16 M20 M32	PG13,5 PG16 PG21 PG29		12	12	23	1.250 / 900
3	20	20-19	M16 M20 M32	PG13,5 PG16 PG21 PG29		8	8	46	700 / 500
3	22	22-2	M16 M20 M32	PG13,5 PG16 PG29		8	8	46	1.250 / 900
3	22	22-6	M16 M20 M32	PG13,5 PG16 PG29		2x 8 1x 16	8 18-16	46 13	1.250 / 900
3	22	22-9	M16 M20 M32	PG13,5 PG16 PG29		12	12	23	1.750 / 1.250
3	22	22-21	M16 M20 M32	PG13,5 PG16 PG29		1x 0 2x 16	0 18-16	150 13	700 / 500

Polbilder / Baugrößen / elektrische Daten

Polzahl 3

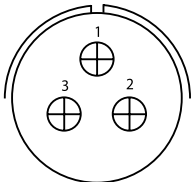
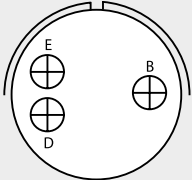
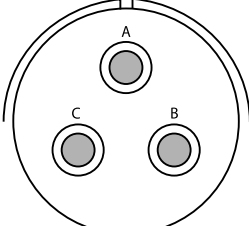
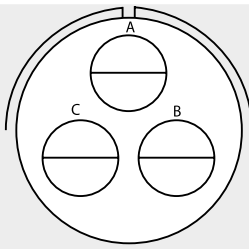
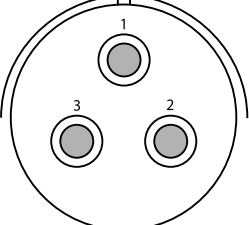
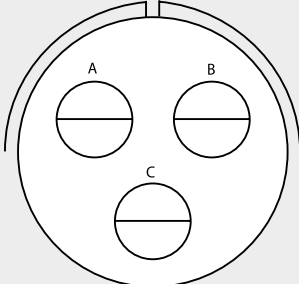
Polzahl	Baugröße	Code XX-XX für Polbild	Code YYY für Schraubadapter		Polbild (Steckseite Stift)	Größe Kontakt	für AWG	Strombelastung A	Spannung max. DC / AC V
			metrisch	Pg					
3	22	22A3	M16 M20 M32	PG13,5 PG16 PG29		12	12	23	2.450 / 1.750
3	24	24-12/1	M20 M25 M40	PG13,5 PG16 PG29		12	12	46	700 / 500
3	28	28-3	M20 M25 M40	PG29 PG36		8	8	46	1.750 / 1.250
3	28	28-6	M20 M25 M40	PG29 PG36		4	4	80	1.250 / 900
3	28	28A3	M20 M25 M40	PG29 PG36		8	8	46	2.450 / 1.750
3	32	32A3	M25 M32 M40	PG21 PG29 PG36		4	4	80	1.750 / 1.250

Polbilder / Baugrößen / elektrische Daten Polzahlen 3-4

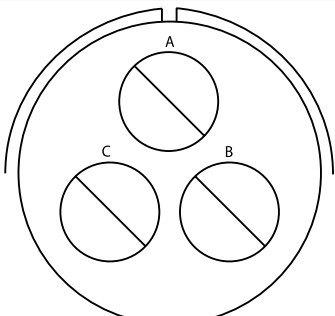
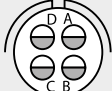
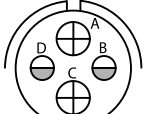
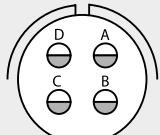
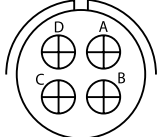
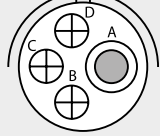
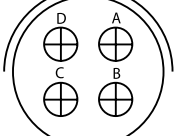
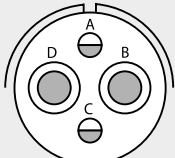
Polzahl	Baugröße	Code XX-XX für Polbild	Code YYY für Schraubadapter		Polbild (Steckseite Stift)	Größe Kontakt	für AWG	Strombelastung A	Spannung max. DC / AC V
			metrisch	Pg					
3	36	36-4	M32 M40	PG21 PG29 PG36		0	0	150	1.250 / 900 = A; 700 / 500 = B,C
4	14S	14S-2	M12 M20	PG7 PG11 PG16		16	18-16	13	250 / 200
4	16	16-9	M16	PG11 PG13,5 PG16		2x 12 2x 16	12 18-16	23 13	700 / 500
4	18	18-4	M25	PG13,5 PG21		16	18-16	13	1.250 / 900
4	18	18-10	M25	PG13,5 PG21		12	12	23	700 / 500
4	18	18-13	M25	PG13,5 PG21		1x 8 3x 12	8 12	46 23	700 / 500
4	20	20-4	M16 M20 M32	PG13,5 PG16 PG21 PG29		12	12	23	1.250 / 900
4	20	20-24	M16 M20 M32	PG13,5 PG16 PG21 PG29		2x 8 2x 16	8 18-16	46 13	700 / 500

Polbilder / Baugrößen / elektrische Daten Polzahlen 4-5

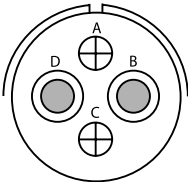
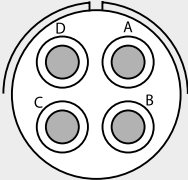
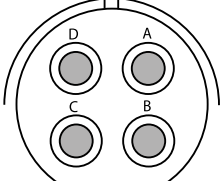
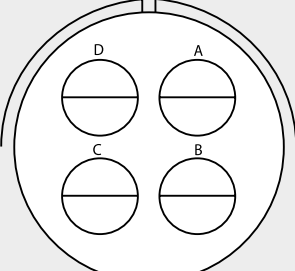
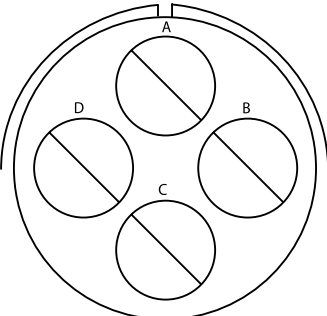
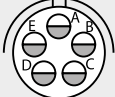
Polzahl	Baugröße	Code XX-XX für Polbild	Code YYY für Schraubadapter		Polbild (Steckseite Stift)	Größe Kontakt	für AWG	Strombelastung A	Spannung max. DC / AC V
			metrisch	Pg					
4	22	22-4	M16 M20 M32	PG13,5 PG16 PG29		2x 8 2x 12	8 12	46 23	700 / 500
4	22	22-22	M16 M20 M32	PG13,5 PG16 PG29		8	8	46	700 / 500
4	24	24-22	M20 M25 M40	PG13,5 PG16 PG29		8	8	46	1.250 / 900
4	32	32-17	M25 M32 M40	PG21 PG29 PG36		4	4	80	1.250 / 900
4	36	36-5	M32 M40	PG21 PG29 PG36		0	0	150	700 / 500
5	14S	14S-5	M12 M20	PG7 PG11 PG16		16	18-16	13	250 / 200

Polbilder / Baugrößen / elektrische Daten Polzahl 5

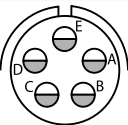
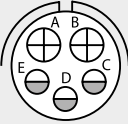
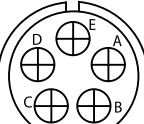
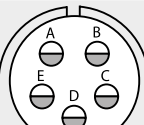
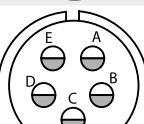
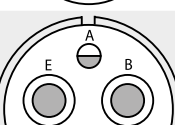
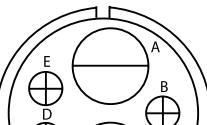
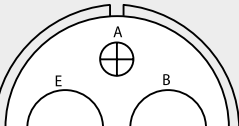
Polzahl	Baugröße	Code XX-XX für Polbild	Code YYY für Schraubadapter		Polbild (Steckseite Stift)	Größe Kontakt	für AWG	Strombelastung A	Spannung max. DC / AC V
			metrisch	Pg					
5	16S	16S-8	M16	PG11 PG13,5 PG16		16	18-16	13	700 / 500
5	16	16A5	M16	PG11 PG13,5 PG16		2x 12 3x 16	12 18-16	23 13	700 / 500
5	18	18-11	M25	PG13,5 PG21		12	12	23	700 / 500
5	18	18-20	M25	PG13,5 PG21		16	18-16	13	700 / 500
5	18	18A5	M25	PG13,5 PG21		16	18-16	13	1.250 / 900
5	22	22-12	M16 M20 M32	PG13,5 PG16 PG29		2x 8 3x 16	8 18-16	46 13	1.250 / 900
5	24	24-12	M20 M25 M40	PG13,5 PG16 PG29		2x 4 3x 12	4 12	80 23	700 / 500
5	28	28-5	M20 M25 M40	PG29 PG36		2x 4 1x 12 2x 16	4 12 18-16	80 23 13	1.250 / 900

Polbilder / Baugrößen / elektrische Daten Polzahlen 5-6

Polzahl	Baugröße	Code XX-XX für Polbild	Code YYYY für Schraubadapter metrisch		Polbild (Steckseite Stift)	Größe Kontakt	für AWG	Strombelastung A	Spannung max. DC / AC V
				Pg					
5	32	32-1	M25 M32 M40	PG21 PG29 PG36		2x 0 3x 12	0 12	150 23	1.250 / 900; 1.750 / 1.250 = A
5	32	32-2	M25 M32 M40	PG21 PG29 PG36		3x 4 2x 16	4 18-16	80 13	1.750 / 1.250
5	32	32-79	M25 M32 M40	PG21 PG29 PG36		4x 4 1x 8	4 8	80 46	1.250 / 900
5	32	32A5	M25 M32 M40	PG21 PG29 PG36		4	4	80	1.250 / 900
6	14S	14S-6	M12 M20	PG7 PG11 PG16		16	18-16	13	250 / 200
6	18	18-06	M25	PG13,5 PG21		4x 12 2x 16	12 18-16	23 13	700 / 500

Polbilder / Baugrößen / elektrische Daten Polzahl 6

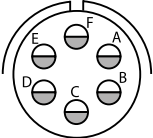
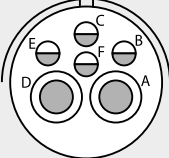
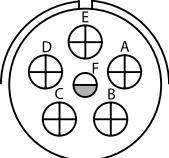
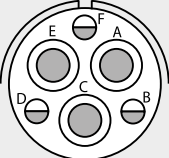
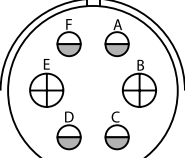
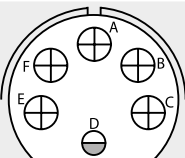
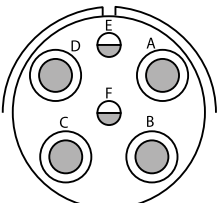
Polzahl	Baugröße	Code XX-XX für Polbild	Code YYY für Schraubadapter		Polbild (Steckseite Stift)	Größe Kontakt	für AWG	Strombelastung A	Spannung max. DC / AC V
			metrisch	Pg					
6	18	18-12	M25	PG13,5 PG21		16	18-16	13	700 / 500
6	20	20-8	M16 M20 M32	PG13,5 PG16 PG21 PG29		2x 8 4x 16	8 18-16	46 13	250 / 200
6	20	20-17	M16 M20 M32	PG13,5 PG16 PG21 PG29		5x 12 1x 16	12 18-16	23 13	700 / 500
6	20	20-22	M16 M20 M32	PG13,5 PG16 PG21 PG29		3x 8 3x 16	8 18-16	46 13	700 / 500
6	22	22-5	M16 M20 M32	PG13,5 PG16 PG29		2x 12 4x 16	12 18-16	23 13	1.250 / 900
6	22	22-15	M16 M20 M32	PG13,5 PG16 PG29		5x 12 1x 16	12 18-16	23 13	700 / 500; 1.750 / 1.250 = D
6	24	24-06	M20 M25 M40	PG13,5 PG16 PG29		4x 8 2x 16	8 18-16	46 13	1.250 / 900

Polbilder / Baugrößen / elektrische Daten Polzahlen 6-7

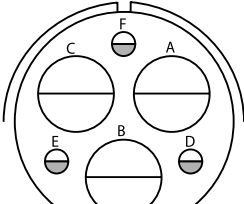
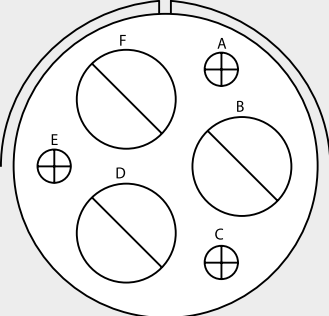
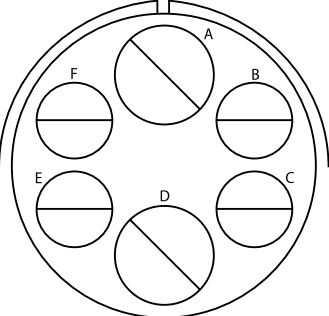
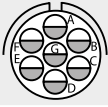
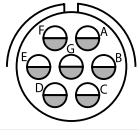
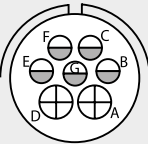
Polzahl	Baugröße	Code XX-XX für Polbild	Code YYY für Schraubadapter		Polbild (Steckseite Stift)	Größe Kontakt	für AWG	Strombelastung A	Spannung max. DC / AC V
			metrisch	Pg					
6	28	28-22	M20 M25 M40	PG29 PG36		3x 4 3x 16	4 18-16	80 13	1.250 / 900
6	36	36-3	M32 M40	PG21 PG29 PG36		3x 0 3x 12	0 12	150 23	1.250 / 900
6	36	36-6	M32 M40	PG21 PG29 PG36		2x 0 4x 4	0 4	150 80	700 / 500
7	14S	14SA7	M12 M20	PG7 PG11 PG16		16	18-16	13	250 / 200
7	16S	16S-1	M16	PG11 PG13,5 PG16		16	18-16	13	700 / 500
7	18	18-9	M25	PG13,5 PG21		2x 12 5x 16	12 18-16	23 13	250 / 200

Polbilder / Baugrößen / elektrische Daten Polzahl 7

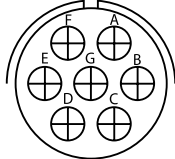
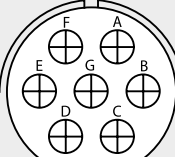
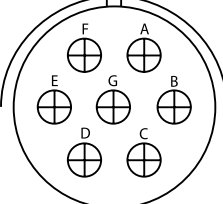
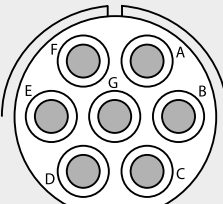
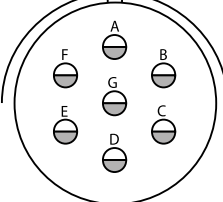
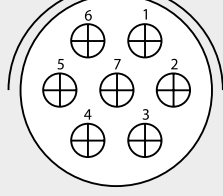
Polzahl	Baugröße	Code XX-XX für Polbild	Code YYY für Schraubadapter		Polbild (Steckseite Stift)	Größe Kontakt	für AWG	Strombelastung A	Spannung max. DC / AC V
			metrisch	Pg					
7	20	20-15	M16 M20 M32	PG13,5 PG16 PG21 PG29		12	12	23	700 / 500
7	22	22-28	M16 M20 M32	PG13,5 PG16 PG29		12	12	23	700 / 500
7	24	24-2	M20 M25 M40	PG13,5 PG16 PG29		12	12	23	1.250 / 900
7	24	24-10	M20 M25 M40	PG13,5 PG16 PG29		8	8	46	700 / 500
7	24	24-27	M20 M25 M40	PG13,5 PG16 PG29		16	18-16	13	1.750 / 1.250
7	24	24A7	M20 M25 M40	PG13,5 PG16 PG29		12	12	23	1.250 / 900

Polbilder / Baugrößen / elektrische Daten Polzahlen 7-8

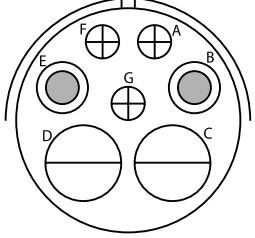
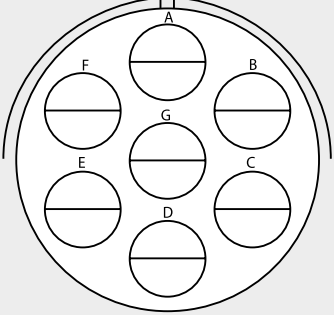
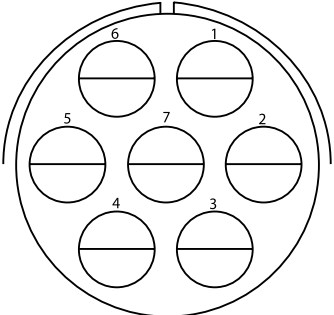
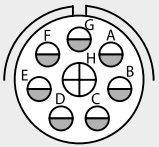
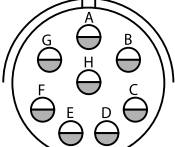
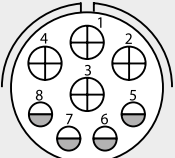
Polzahl	Baugröße	Code XX-XX für Polbild	Code YYY für Schraubadapter		Polbild (Steckseite Stift)	Größe Kontakt	für AWG	Strombelastung A	Spannung max. DC / AC V
			metrisch	Pg					
7	28	28-10	M20 M25 M40	PG29 PG36		2x 4 2x 8 3x 12	4 8 12	80 46 23	700 / 500; 1.250 / 900 = G
7	36	36-77	M32 M40	PG21 PG29 PG36		4	4	80	1.250 / 900
7	36	36A7	M32 M40	PG21 PG29 PG36		4	4	80	2.450 / 1.750
8	18	18-8	M25	PG13,5 PG21		1x 12 7x 16	12 18-16	23 13	700 / 500
8	20	20-7	M16 M20 M32	PG13,5 PG16 PG21 PG29		16	18-16	13	700 / 500; 1.250 / 900 = A,B,G,H
8	20	20B8	M16 M20 M32	PG13,5 PG16 PG21 PG29		4x 12 4x 16	12 18-16	23 13	700 / 500

Polbilder / Baugrößen / elektrische Daten Polzahlen 8-9

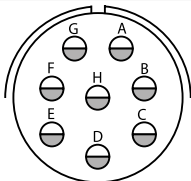
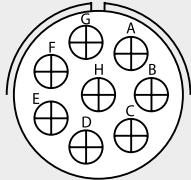
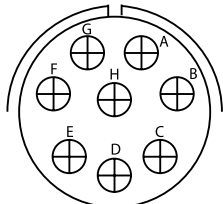
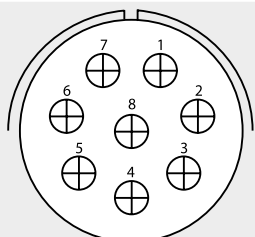
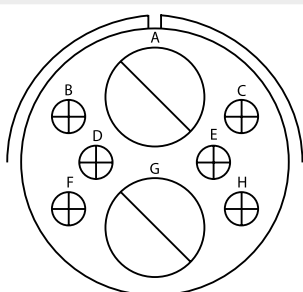
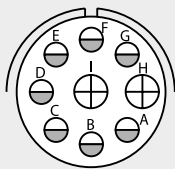
Polzahl	Baugröße	Code XX-XX für Polbild	Code YYY für Schraubadapter		Polbild (Steckseite Stift)	Größe Kontakt	für AWG	Strombelastung A	Spannung max. DC / AC V
			metrisch	Pg					
8	22	22-18	M16 M20 M32	PG13,5 PG16 PG29		16	18-16	13	700 / 500
8	22	22-23	M16 M20 M32	PG13,5 PG16 PG29		12	12	23	700 / 500; 1.250 / 900 = H
8	24	24-6	M20 M25 M40	PG13,5 PG16 PG29		12	12	23	700 / 500; 1.250 / 900 = A,G,H
8	28	28B8	M20 M25 M40	PG29 PG36		12	12	23	750
8	32	32-15	M25 M32 M40	PG21 PG29 PG36		2x 0 6x 12	0 12	150 23	1.250 / 900
9	20	20-16	M16 M20 M32	PG13,5 PG16 PG21 PG29		2x 12 7x 16	12 18-16	23 13	700 / 500

Polbilder / Baugrößen / elektrische Daten

Polzahl 9

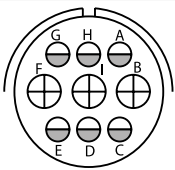
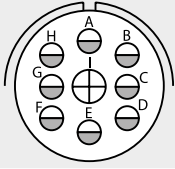
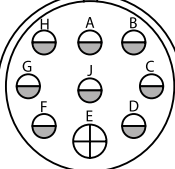
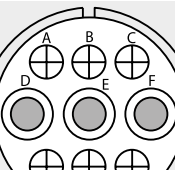
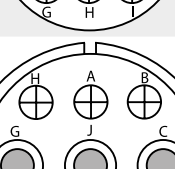
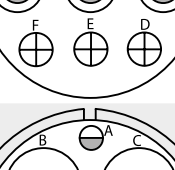
Polzahl	Baugröße	Code XX-XX für Polbild	Code YYY für Schraubadapter		Polbild (Steckseite Stift)	Größe Kontakt	für AWG	Strombelastung A	Spannung max. DC / AC V
			metrisch	Pg					
9	20	20-18	M16 M20 M32	PG13,5 PG16 PG21 PG29		3x 12 6x 16	12 18-16	23 13	700 / 500
9	20	20-21	M16 M20 M32	PG13,5 PG16 PG21 PG29		1x 12 8x 16	12 18-16	23 13	700 / 500
9	22	22-17	M16 M20 M32	PG13,5 PG16 PG29		1x 12 8x 16	12 18-16	23 13	700 / 500; 1.250 / 900 = A
9	24	24-11	M20 M25 M40	PG13,5 PG16 PG29		3x 8 6x 12	8 12	46 23	700 / 500
9	28	28-1	M20 M25 M40	PG29 PG36		3x 8 6x 12	8 12	46 23	700 / 500; 1.250 / 900 = A,E,J
9	28	28A9	M20 M25 M40	PG29 PG36		4x 4 5x 16	4 18-16	80 13	700 / 500

Polbilder / Baugrößen / elektrische Daten Polzahlen 9-10

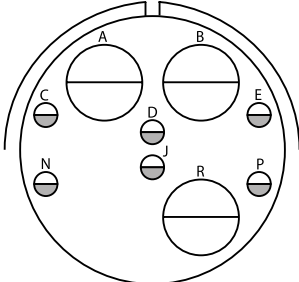
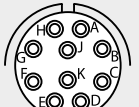
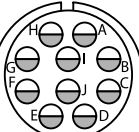
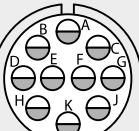
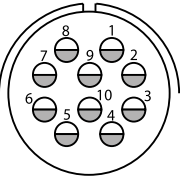
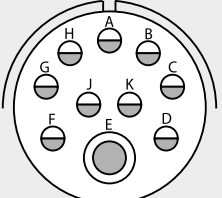
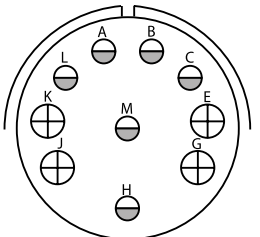
Polzahl	Baugröße	Code XX-XX für Polbild	Code YYY für Schraubadapter		Polbild (Steckseite Stift)	Größe Kontakt	für AWG	Strombelastung A	Spannung max. DC / AC V
			metrisch	Pg					
9	32	32A9	M25 M32 M40	PG21 PG29 PG36		3x 4 6x 16	4 18-16	80 13	700 / 500
10	16	16A10	M16	PG11 PG13,5 PG16		18	26-20	7,5	700 / 500
10	18	18-1	M25	PG13,5 PG21		16	18-16	13	250 / 200; 700 / 500 =B,C,F,G
10	18	18-19	M25	PG13,5 PG21		16	18-16	13	700 / 500
10	22	22A10	M16 M20 M32	PG13,5 PG16 PG29		16	18-16	13	700 / 500
10	24	24-21	M20 M25 M40	PG13,5 PG16 PG29		1x 8 9x 16	8 18-16	46 13	1.250 / 900
10	28	28-19	M20 M25 M40	PG29 PG36		4x 12 6x 16	12 18-16	23 13	700 / 500; 2.450 / 1.750 = H,M; 1.250 / 900 =B

Polbilder / Baugrößen / elektrische Daten Polzahlen 10-12

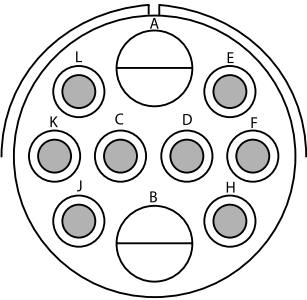
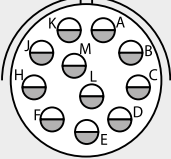
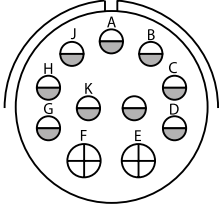
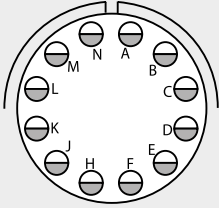
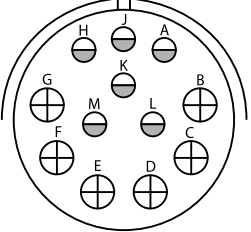
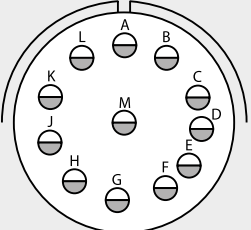
Polzahl	Baugröße	Code XX-XX für Polbild	Code YYY für Schraubadapter		Polbild (Steckseite Stift)	Größe Kontakt	für AWG	Strombelastung A	Spannung max. DC / AC V
			metrisch	Pg					
10	36	36A10	M32 M40	PG21 PG29 PG36		2x 4 8x 8	4 8	80 46	700 / 500
11	20	20-33	M16 M20 M32	PG13,5 PG16 PG21 PG29		16	18-16	13	700 / 500
11	24	24-20	M20 M25 M40	PG13,5 PG16 PG29		2x 12 9x 16	12 18-16	23 13	1.250 / 900
12	24	24-19	M20 M25 M40	PG13,5 PG16 PG29		16	18-16	13	700 / 500
12	28	28-9	M20 M25 M40	PG29 PG36		6x 12 6x 16	12 18-16	23 13	1.250 / 900
12	28	28-18	M20 M25 M40	PG29 PG36		16	18-16	13	250 / 200; 4.200 / 3.000 = M; 700 / 500 = A,B; 1.250 / 900 = G,H,J,K,L

Polbilder / Baugrößen / elektrische Daten Polzahlen 12-14

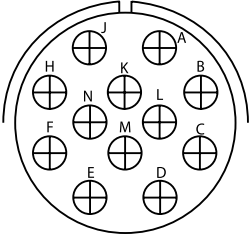
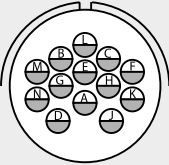
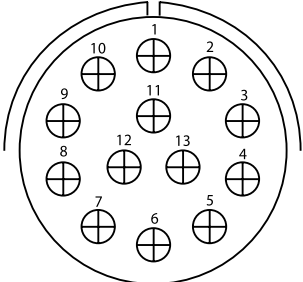
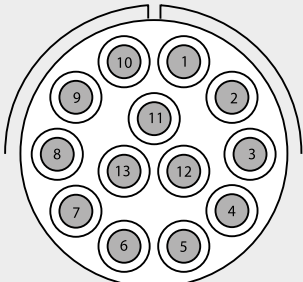
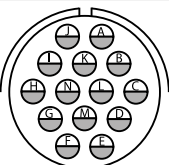
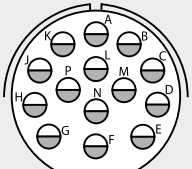
Polzahl	Baugröße	Code XX-XX für Polbild	Code YYY für Schraubadapter		Polbild (Steckseite Stift)	Größe Kontakt	für AWG	Strombelastung A	Spannung max. DC / AC V
			metrisch	Pg					
12	28	28-51	M20 M25 M40	PG29 PG36		12	12	23	1.250 / 900
13	20	20-11	M16 M20 M32	PG13,5 PG16 PG21 PG29		16	18-16	13	250 / 200
13	32	32A13	M25 M32 M40	PG21 PG29 PG36		12	12	23	1.250 / 900
13	32	32B13	M25 M32 M40	PG21 PG29 PG36		8	8	46	700 / 500
14	20	20-27	M16 M20 M32	PG13,5 PG16 PG21 PG29		16	18-16	13	700 / 500
14	22	22-19	M16 M20 M32	PG13,5 PG16 PG29		16	18-16	13	700 / 500

Polbilder / Baugrößen / elektrische Daten Polzahlen 14-15

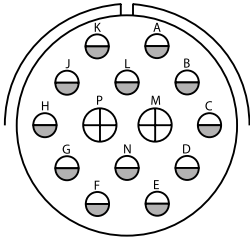
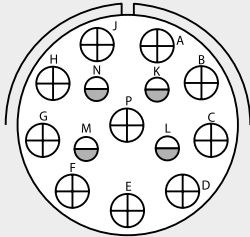
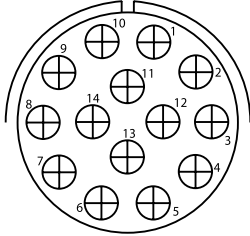
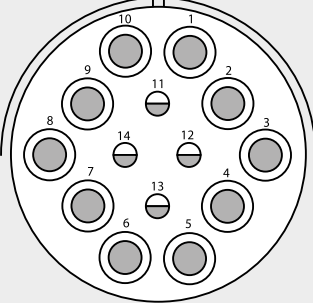
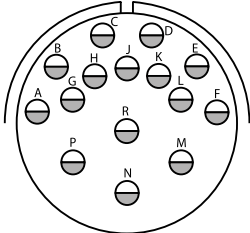
Polzahl	Baugröße	Code XX-XX für Polbild	Code YYY für Schraubadapter		Polbild (Steckseite Stift)	Größe Kontakt	für AWG	Strombelastung A	Spannung max. DC / AC V
			metrisch	Pg					
14	28	28-2	M20 M25 M40	PG29 PG36		2x 12 12x 16	12 18-16	23 13	1.250 / 900
14	28	28-20	M20 M25 M40	PG29 PG36		10x 12 4x 16	12 18-16	23 13	700 / 500
14	28	28A14	M20 M25 M40	PG29 PG36		12	12	23	700 / 500
14	36	36D78	M32 M40	PG21 PG29 PG36		10x 8 4x 16	8 18-16	46 13	1.250 / 900
15	28	28-17	M20 M25 M40	PG29 PG36		16	18-16	13	700 / 500; 1.250 / 900 = M,N,P; 2.450 / 1.750 = R

Polbilder / Baugrößen / elektrische Daten Polzahlen 16-17

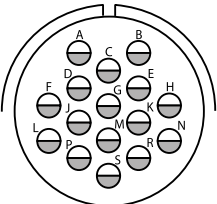
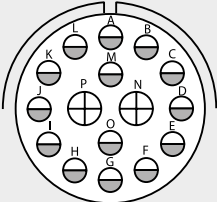
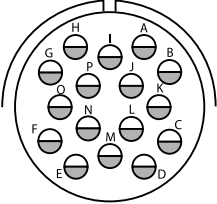
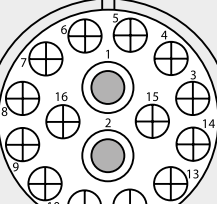
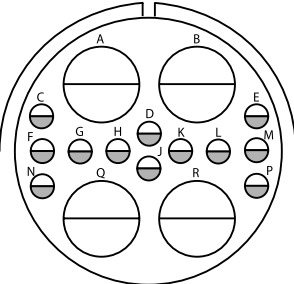
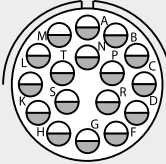
Polzahl	Baugröße	Code XX-XX für Polbild	Code YYY für Schraubadapter		Polbild (Steckseite Stift)	Größe Kontakt	für AWG	Strombelastung A	Spannung max. DC / AC V
			metrisch	Pg					
16	24	24-5	M20 M25 M40	PG13,5 PG16 PG29		16	18-16	13	700 / 500
16	24	24-7	M20 M25 M40	PG13,5 PG16 PG29		2x 12 14x 16	12 18-16	23 13	700 / 500
16	24	24A16	M20 M25 M40	PG13,5 PG16 PG29		16	18-16	13	1.250 / 900
16	28	28A16	M20 M25 M40	PG29 PG36		2x 8 14x 12	8 12	46 23	700 / 500
16	32	32-68	M25 M32 M40	PG21 PG29 PG36		4x 4 12x 16	4 12	80 13	700 / 500
17	20	20-29	M16 M20 M32	PG13,5 PG16 PG21 PG29		16	18-16	13	700 / 500

Polbilder / Baugrößen / elektrische Daten Polzahlen 17-20

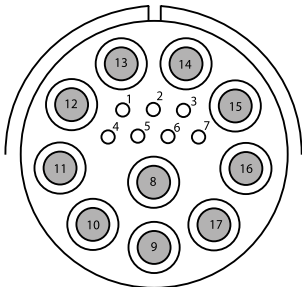
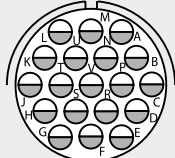
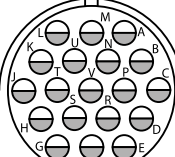
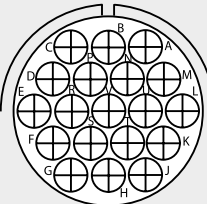
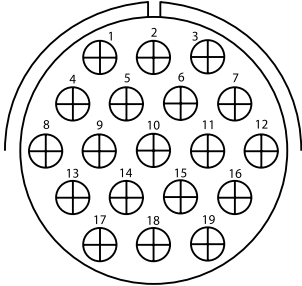
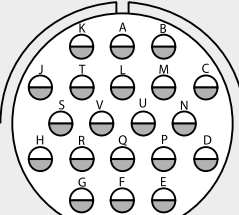
Polzahl	Baugröße	Code XX-XX für Polbild	Code YYY für Schraubadapter		Polbild (Steckseite Stift)	Größe Kontakt	für AWG	Strombelastung A	Spannung max. DC / AC V
			metrisch	Pg					
17	32	32A17	M25 M32 M40	PG21 PG29 PG36		10x 8 7x 20	8 26-22	46 7,5	700 / 500
19	20	20A48	M16 M20 M32	PG13,5 PG16 PG21 PG29		16	18-16	13	250 / 200
19	22	22-14	M16 M20 M32	PG13,5 PG16 PG29		16	18-16	13	700 / 500
19	24	24-67	M20 M25 M40	PG13,5 PG16 PG29		12	12	23	700 / 500
19	32	32-76	M25 M32 M40	PG21 PG29 PG36		12	12	23	700 / 500
20	28	28-16	M20 M25 M40	PG29 PG36		16	18-16	13	700 / 500

Polbilder / Baugrößen / elektrische Daten Polzahlen 22-23

Polzahl	Baugröße	Code XX-XX für Polbild	Code YYY für Schraubadapter		Polbild (Steckseite Stift)	Größe Kontakt	für AWG	Strombelastung A	Spannung max. DC / AC V
			metrisch	Pg					
22	28	28-11	M20 M25 M40	PG29 PG36		4x 12 18x 16	12 18-16	23 13	700 / 500
22	32	32A22	M25 M32 M40	PG21 PG29 PG36		12	12	23	700 / 500
22	36	36A22	M32 M40	PG21 PG29 PG36		12	12	23	1.250 / 900
23	32	32-6	M25 M32 M40	PG21 PG29 PG36		2x 4 3x 8 2x 12 16x 16	4 8 12 18-16	80 46 23 13	700 / 500
23	32	32-13	M25 M32 M40	PG21 PG29 PG36		5x 12 18x 16	12 18-16	23 13	1.250 / 900

Polbilder / Baugrößen / elektrische Daten Polzahlen 24-26

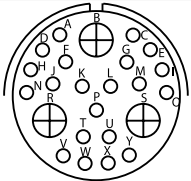
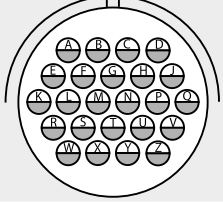
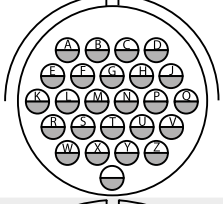
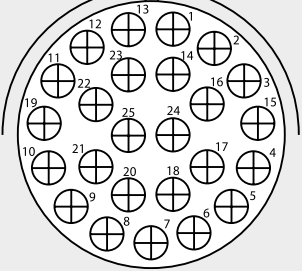
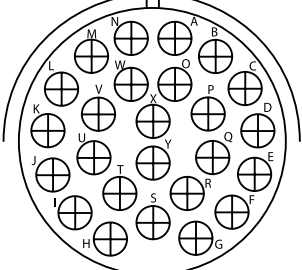
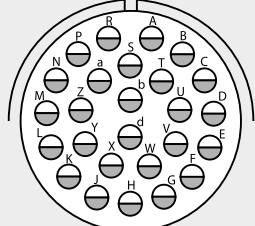
Polzahl	Baugröße	Code XX-XX für Polbild	Code YYY für Schraubadapter		Polbild (Steckseite Stift)	Größe Kontakt	für AWG	Strombelastung A	Spannung max. DC / AC V
			metrisch	Pg					
24	22	22A24	M16 M20 M32	PG13,5 PG16 PG29		3x 12 21x 20	12 26-22	23 7,5	700 / 500
24	24	24-28	M20 M25 M40	PG13,5 PG16 PG29		16	18-16	13	250 / 200
25	24	24A25	M20 M25 M40	PG13,5 PG16 PG29		16	18-16	13	250 / 200
25	32	32A25	M25 M32 M40	PG21 PG29 PG36		12	12	23	700 / 500
25	32	32B25	M25 M32 M40	PG21 PG29 PG36		12	12	23	700 / 500
26	28	28-12	M20 M25 M40	PG29 PG36		16	18-16	13	700 / 500

Polbilder / Baugrößen / elektrische Daten Polzahlen 28-31

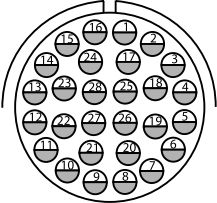
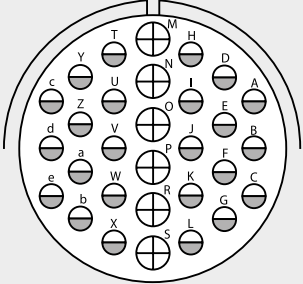
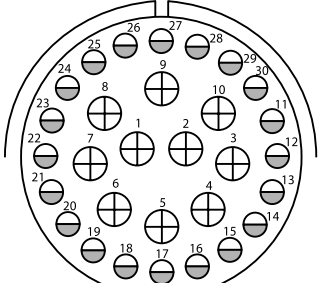
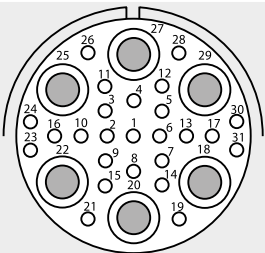
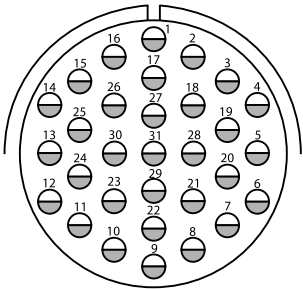
Polzahl	Baugröße	Code XX-XX für Polbild	Code YYY für Schraubadapter		Polbild (Steckseite Stift)	Größe Kontakt	für AWG	Strombelastung A	Spannung max. DC / AC V
			metrisch	Pg					
28	24	24A28	M20 M25 M40	PG13,5 PG16 PG29		16	18-16	13	250 / 200
30	32	32-8	M25 M32 M40	PG21 PG29 PG36		6x 12 24x 16	12 18-16	23 13	700 / 500
30	32	32A30	M25 M32 M40	PG21 PG29 PG36		10x 12 20x 16	12 18-16	23 13	700 / 500
31	28	28A31	M20 M25 M40	PG29 PG36		6x 8 25x 20	8 26-22	46 7,5	700 / 500
31	32	32-31	M25 M32 M40	PG21 PG29 PG36		16	18-16	13	700 / 500

Polbilder / Baugrößen / elektrische Daten Polzahlen 31-35

Polzahl	Baugröße	Code XX-XX für Polbild	Code YYY für Schraubadapter		Polbild (Steckseite Stift)	Größe Kontakt	für AWG	Strombelastung A	Spannung max. DC / AC V
			metrisch	Pg					
31	36	36-9	M32 M40	PG21 PG29 PG36		1x 4 2x 8 14x 12 14x 16	4 8 12 18-16	80 46 23 13	700 / 500
34	32	32A34	M25 M32 M40	PG21 PG29 PG36		3x 8 4x 12 27x 18	8 12 26-20	46 23 7,5	250 / 200; 700 / 500 = 1,2,3,4
35	28	28-15	M20 M25 M40	PG29 PG36		16	18-16	13	700 / 500
35	28	28A35	M20 M25 M40	PG29 PG36		16	18-16	13	700 / 500
35	32	32-7	M25 M32 M40	PG21 PG29 PG36		7x 12 28x 16	12 18-16	23 13	700 / 500; 250 / 200 = A,B,h,j

Polbilder / Baugrößen / elektrische Daten Polzahlen 35-42

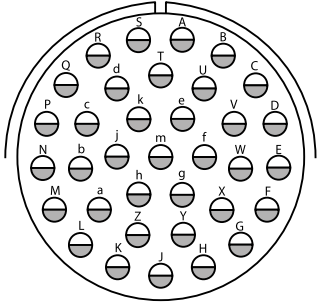
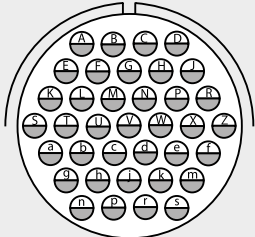
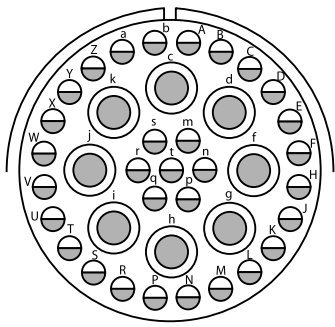
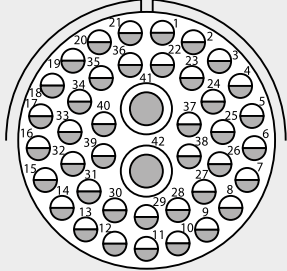
Polzahl	Baugröße	Code XX-XX für Polbild	Code YYY für Schraubadapter		Polbild (Steckseite Stift)	Größe Kontakt	für AWG	Strombelastung A	Spannung max. DC / AC V
			metrisch	Pg					
35	36	36-15	M32 M40	PG21 PG29 PG36		16	18-16	13	700 / 500; 1.250 / 900 = M
37	28	28-21	M20 M25 M40	PG29 PG36		16	18-16	13	700 / 500
39	36	36B39	M32 M40	PG21 PG29 PG36		8x 8 31x 16	8 18-16	46 13	700 / 500
42	32	32-59	M25 M32 M40	PG21 PG29 PG36		2x 8 40x 16	8 18-16	46 13	700 / 500

Polbilder / Baugrößen / elektrische Daten Polzahlen 47-48

Polzahl	Baugröße	Code XX-XX für Polbild	Code YYY für Schraubadapter		Polbild (Steckseite Stift)	Größe Kontakt	für AWG	Strombelastung A	Spannung max. DC / AC V
			metrisch	Pg					
47	36	36-7	M32 M40	PG21 PG29 PG36		7x 12 40x 16	12 18-16	23 13	700 / 500
47	36	36-8	M32 M40	PG21 PG29 PG36		1x 12 46x 16	12 18-16	23 13	700 / 500
48	32	32A48	M25 M32 M40	PG21 PG29 PG36		16	18-16	13	250 / 200
48	36	36-10	M32 M40	PG21 PG29 PG36		16	18-16	13	700 / 500

Polbilder / Baugrößen / elektrische Daten Polzahlen 54-72

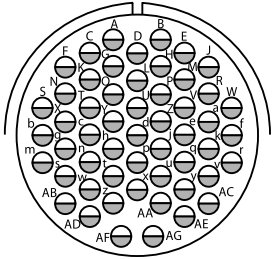
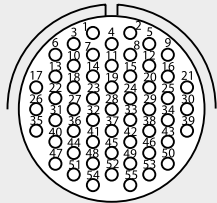
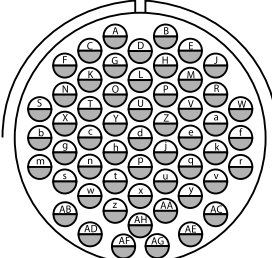
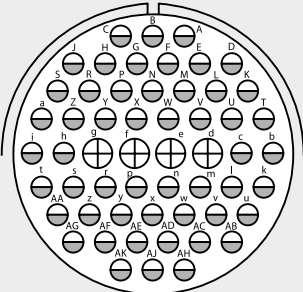
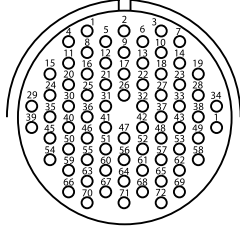
Polzahl	Baugröße	Code XX-XX für Polbild	Code YYY für Schraubadapter		Polbild (Steckseite Stift)	Größe Kontakt	für AWG	Strombelastung A	Spannung max. DC / AC V
			metrisch	Pg					
54	32	32-22	M25 M32 M40	PG21 PG29 PG36		16	18-16	13	700 / 500
55	24	24A55	M20 M25 M40	PG13,5 PG16 PG29		20	26-22	7,5	250 / 200
55	32	32A55	M25 M32 M40	PG21 PG29 PG36		16	18-16	13	700 / 500
56	36	36-66	M32 M40	PG21 PG29 PG36		4x 12 52x 16	12 18-16	23 13	700 / 500
72	28	28-72	M20 M25 M40	PG29 PG36		20	26-22	7,5	250 / 200