

DIN-Signal contact BC,F,PL2,500 reel



Image is for illustration purposes only. Please refer to product description.

Part number	09 02 000 8434
Specification	DIN-Signal contact BC,F,PL2,500 reel
HARTING eCatalogue	https://b2b.harting.com/09020008434

Identification

Category	Contacts
Series	DIN 41612
Type of contact	Crimp contact
Contacts for	DIN 41612 Type B DIN 41612 Type C DIN 41612 Type 2C DIN 41612 Type 3C
Features	lead-free

Version

Gender	Female contact
Manufacturing process	Stamped contacts
Pack contents	500 bandoliered contacts

Technical characteristics

Conductor cross-section	0.09 ... 0.5 mm ²
Conductor cross-section	AWG 28 ... AWG 20
Wire outer diameter	0.7 ... 1.5 mm
Rated current	≤2 A
Contact resistance	≤20 mΩ
Stripping length	3.5 ... 4 mm
Performance level	2 acc. to IEC 60603-2



Pushing Performance
Since 1945

Technical characteristics

Mating cycles	≥400
---------------	------

Material properties

Material (contacts)	Copper alloy
Surface (contacts)	Noble metal over Ni Mating side Ni Termination side
RoHS	compliant
ELV status	compliant
China RoHS	e
REACH Annex XVII substances	Not contained
REACH ANNEX XIV substances	Not contained
REACH SVHC substances	Not contained
California Proposition 65 substances	Yes
California Proposition 65 substances	Nickel

Specifications and approvals

Specifications	IEC 60603-2 (complementary)
----------------	-----------------------------

Commercial data

Packaging size	1
Net weight	65 g
Country of origin	Germany
European customs tariff number	85366990
GTIN	5713140002951
ETIM	EC000796
eCl@ss	27440204 Contact for industrial connectors

Current carrying capacity

The current carrying capacity of the connectors is limited by the thermal load capability of the contact element material including the connections and the insulating parts. The derating curve is therefore valid for currents which flow constantly (non-intermittent) through each contact element of the connector evenly, without exceeding the allowed maximum temperature.

Measuring and testing techniques acc. to IEC 60512-5-2

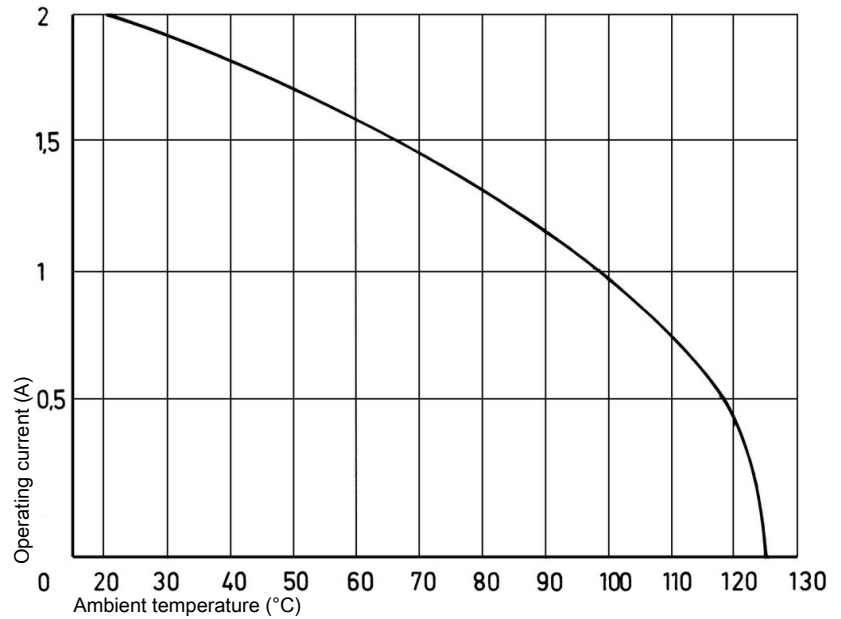

Installation of crimp contacts

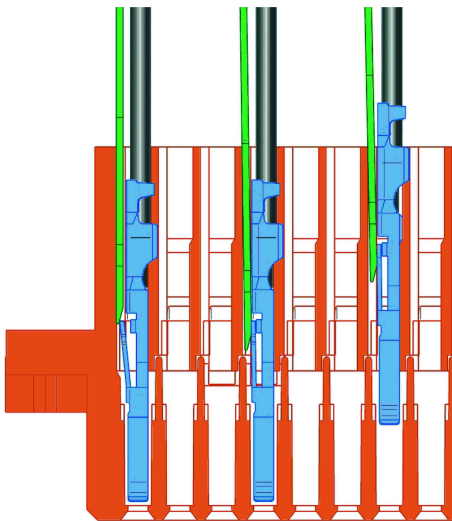

Fitting the crimp contacts:

After crimping the wires onto the contacts with the help of a crimping tool or an automatic crimping machine the contacts should be correctly oriented and inserted into the cavities of the connector moulding in the required configuration. They snap into position and are firmly held in place. A light pull on the wire assures the correct tensile strength of the contact. When using stranded wires with a gauge below 0.37 mm^2 an insertion tool is necessary. Insertion tool part number: 09 99 000 0100

Insertion tool part number: 09 99 000 0100

Removing the crimp contacts:

The removal tool is inserted into a slot on the side of the respective crimp cavity. This action compresses the contact retaining spring therefore the contact can then be easily withdrawn using a light pull on the wire. This action will cause no damage to the contact / wire which can be repositioned / refitted as necessary. The drawing demonstrates the crimp removal procedure (max. 5x).

Removal tool part number: 09 99 000 0101