

Product Declaration Certificate

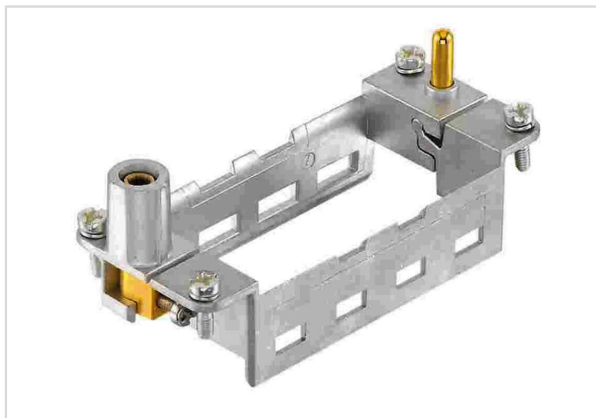

Image is for illustration purposes only. Please refer to product description.

Part number	09 14 216 0313
Specification	Hinged frame HMC 16B f. 4 modules (a..d)
HARTING eCatalogue	https://b2b.harting.com/09142160313

RoHS	compliant with exemption
RoHS exemptions	6(c): Copper alloy containing up to 4 % lead by weight
ELV status	compliant with exemption
China RoHS	50
REACH Annex XVII substances	Not contained
REACH ANNEX XIV substances	Not contained
REACH SVHC substances	Yes
REACH SVHC substances	Lead
ECHA SCIP number	564b7d75-7bf6-4cfb-acb1-2168eb61b675
California Proposition 65 substances	Yes
California Proposition 65 substances	Lead Nickel

RoHS: Directive 2011/65/EU with all amending directives and regulations in force at the declaration's creation date.

ELV status: Directive 2000/53/EC with all amending directives and regulations in force at the declaration's creation date.

REACH ANNEX: Regulation (EU) No. 1907/2006 with all amending directives and regulations in force at the declaration's creation date.

REACH SVHC substances: We applied "Candidate List of substances of very high concern for Authorisation" of ECHA valid on the declaration's creation date.

ECHA SCIP: Article notification number in the SCIP Data base of the European Chemicals Agency (ECHA) according to Waste Frame Directive 2008/89/EC with amended directive 2018/851 in Article 9