

A

B

C

D

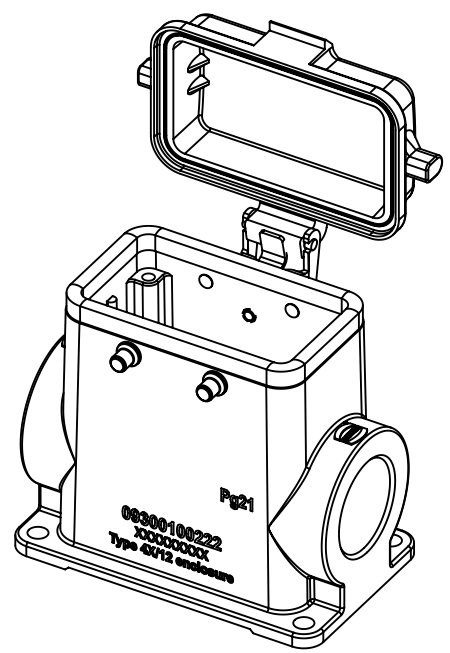
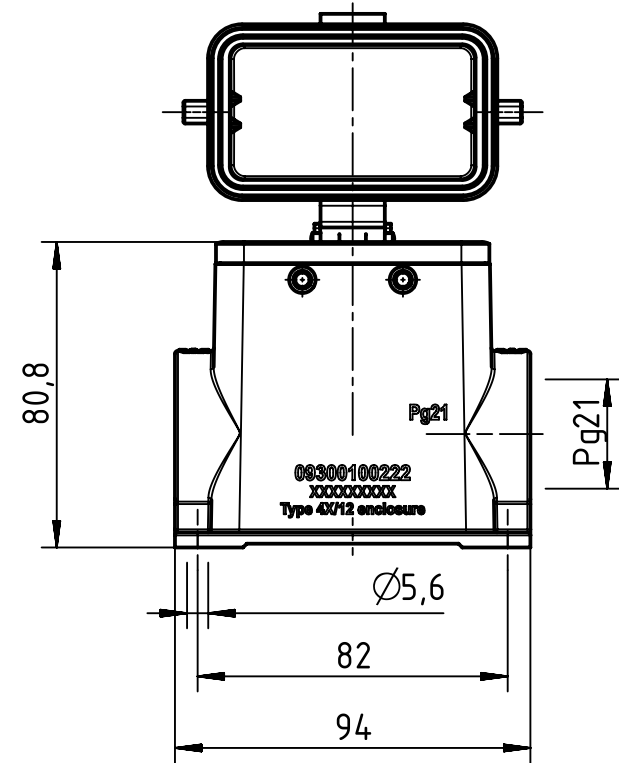
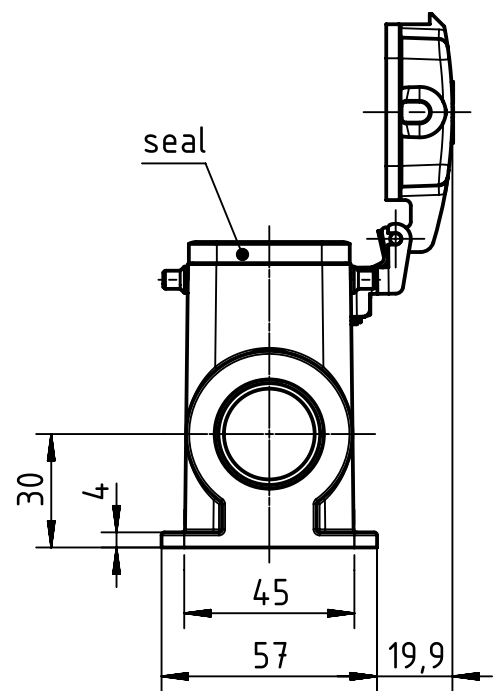

	All Dimensions in mm Original Size DIN A4		Scale 1:2	Free size tol.		Ref.		
						Sub.		
	All rights reserved		Created by SPRENB	Inspected by GERB	Standardisation GARSKE	Date 2019-12-04	State Final Release	
	Department EL PD		Title Han 10B-asg1-K-21				Doc-Key / ECM-Nr. 100208945/UGD/004/C 500000161045	
HARTING Electric GmbH & Co. KG D-32339 Espelkamp			Type TB	Number 09 30 010 0222			Rev. C	Page 1/1