

Han HsB-SMC-MC-CRT-6 mm² / 10 AWG-Ag

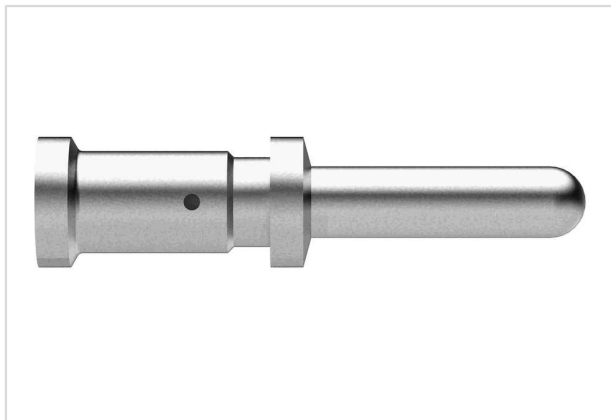

Image is for illustration purposes only. Please refer to product description.

Part number	09 31 000 6102
Specification	Han HsB-SMC-MC-CRT-6 mm ² / 10 AWG-Ag
HARTING eCatalogue	https://b2b.harting.com/09310006102

Identification

Category	Contacts
Series	Han [®] HsB
Type of contact	Crimp contact

Version

Gender	Male
Manufacturing process	Turned contacts

Technical characteristics

Conductor cross-section	6 mm ²
Conductor cross-section	AWG 10
Rated current	≤35 A
Contact resistance	≤1 mΩ
Stripping length	9.5 mm

Material properties

Material (contacts)	Copper alloy
Surface (contacts)	Silver plated
RoHS	compliant with exemption
RoHS exemptions	6(c): Copper alloy containing up to 4 % lead by weight
ELV status	compliant with exemption
China RoHS	50
REACH Annex XVII substances	Not contained



Pushing Performance
Since 1945

Material properties

REACH ANNEX XIV substances	Not contained
REACH SVHC substances	Yes
REACH SVHC substances	Lead
California Proposition 65 substances	Yes
California Proposition 65 substances	Lead

Specifications and approvals

Specifications	IEC 60664-1
	IEC 61984

Commercial data

Packaging size	25
Net weight	2.73 g
Country of origin	Germany
European customs tariff number	85366990
GTIN	5713140188006
ETIM	EC000796
eCl@ss	27440204 Contact for industrial connectors