

1 2 3 4 5 6



A

B

C

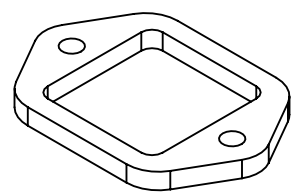
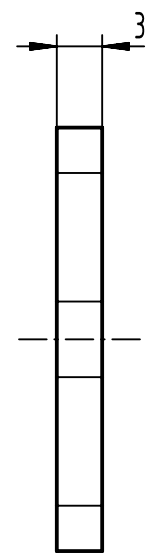
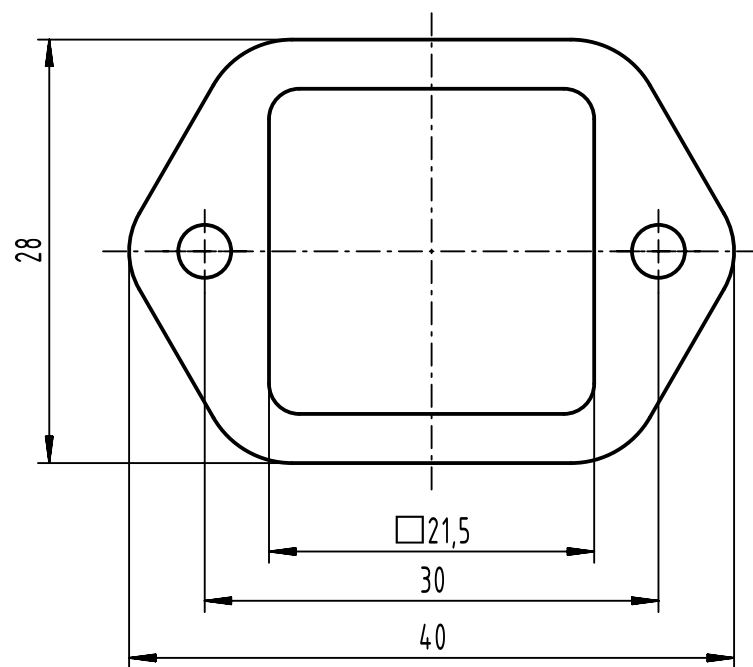
D

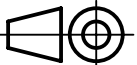

	 All Dimensions in mm Original Size DIN A4	Scale 2:1	Free size tol.		Ref.
	 All rights reserved Department EL PD	Created by HELLMANN	Inspected by GERB	Standardisation	Date 2023-04-05
 HARTING D-32339 Espelkamp		Title Flanschgummidichtung			Doc-Key / ECM-Nr. 100089462/UGD/006/A 500000240970
		Type TB	Number 09 37 000 9912		Rev. A Page 1/1