

1 2 3 4 5 6

A

B

C

D

X (2:1)

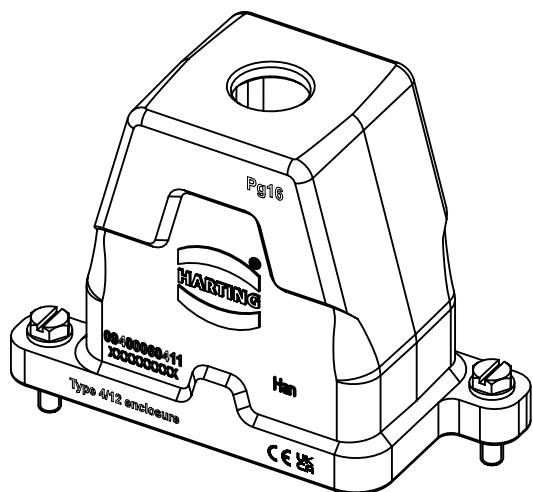
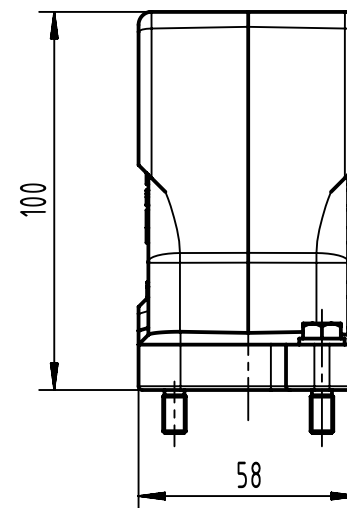
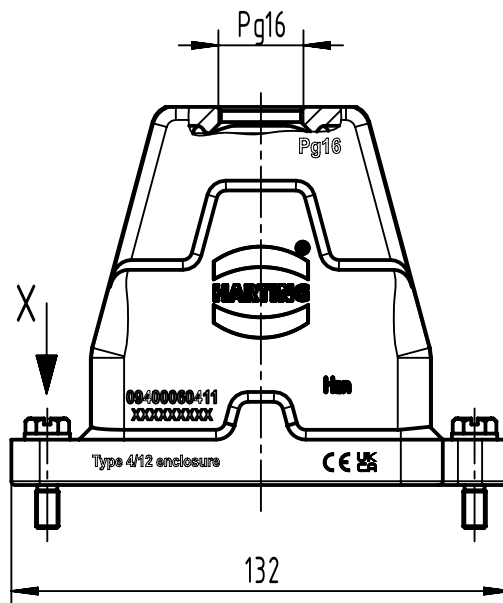
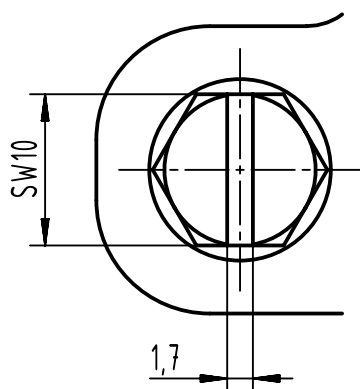

	All Dimensions in mm Original Size DIN A4	Scale	Free size tol.		Ref.	
		1:2			Sub.	
	All rights reserved Department EL PD	Created by	Inspected by	Standardisation	Date	State
		DEIMEL	100219		2024-03-07	Final Release
HARTING D-32339 Espelkamp		Title			Doc-Key / ECM-Nr.	
		Han 6HPR Hood Top Entry PG16 Screw lock			100208589/UGD/004/F 500000265117	
		Type	Number	Rev.	Page	
		TB	09 40 006 0411	F	1/1	