

5

4

3

2

1

Hood upper part

Hood lower part

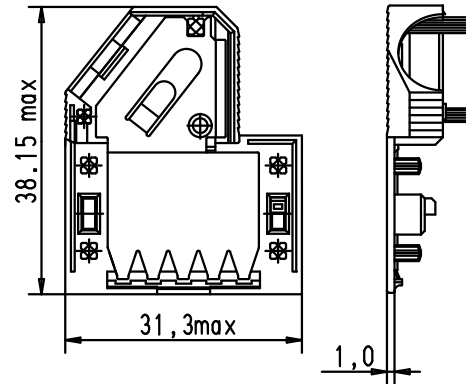
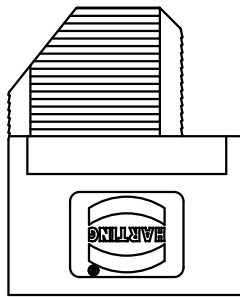
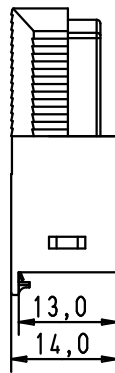
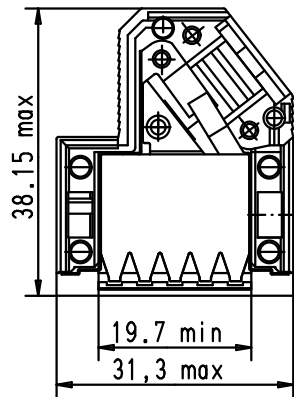

1,0

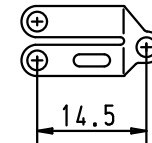
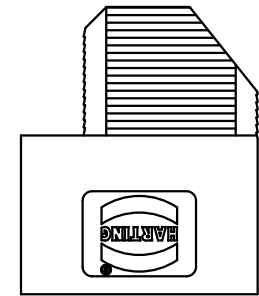

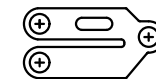

Strain relief 1

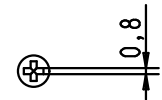
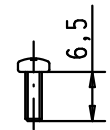

Strain relief 2



Flathead screw

				Det.	27/02/03	Name	S.H.	 <p>All Dim. in mm Orig. Size DIN A 4</p>	D-Sub Hoods 9 POLES with SHELL	Maßstab/ Scale
			Insp.							1 : 1
			Stand.							
EC01696	20/04/10	SC								
31392	27/02/03	S.H.	HARTING EURL F-95972 Paris					TB 09 67 009 0573	Blatt/ Page	
Mod.	Dat.	Name							1 / 1	