

Data sheet

**M12 Industrial Ethernet cable, X-coded, 5.0 m,
M12 plug angled - free line end, coding at 315°, PUR**

Page 1/7

P/N
142M2X90050
EAN 4250184174875
2022/03/16
Version: AR

Illustrations

Produktbild 142M2X90xxx



Dimensional drawing

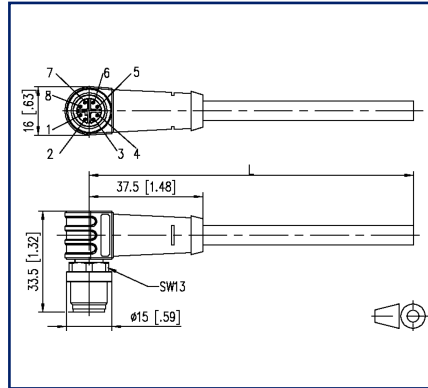

Wiring diagram

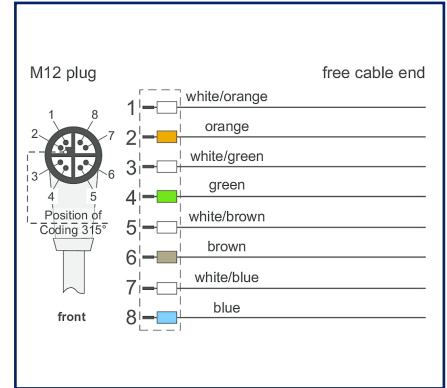

See enlarged drawings at the end of document

Product specification

Shielded PUR cable for safe and industrial data transmission in automation and fieldbus technology. The cable meets the requirements of ULStyle 20963 and complies with Cat7 (electrical properties based on EN50288-4-2). Materials and design allow increased mechanical stress (abrasion, bending, vibration, etc.) of the cable. Special properties: UL style 20963, seawater resistant, recyclable, LABS free, RoHs compliant, acid and alkali resistant, UV resistant, hydrolysis resistant, halogen free, oil resistant, high flexibility, no corrosive gases, microbe resistant, no fire propagation.

- Standard variants: 1.0 m, 2.0 m, 5.0 m, 10.0 m.
- Other cable lengths on request.

P | Cabling

Data sheet

Page 2/7

M12 Industrial Ethernet cable, X-coded, 5.0 m, M12 plug angled - free line end, coding at 315°, PUR

P/N

142M2X90050

EAN 4250184174875

2022/03/16

Version: AR

Technical Data

General Data

Fields of application	Industrial Ethernet, Harsh environment
Design	Ethernet-Connection cable
Shielding	shielded
Transmission technology	Copper
Cable Type	S/FTP
Number of twisting elements	4
Twisting element	Pair
Color coding fiber/ wire(s)	white/orange, orange, white/green, green, white/brown, brown, white/blue, blue
Color	green
Dimensions	
Dimension - Interface 1 (L x W x H)	33.5 mm x 15 mm x 45 mm
Dimension - Interface 1 (L x W x H)	1.319 in. x 0.591 in. x 1.772 in.
Cable length (m)	5 m
Cable length (ft)	16.4 ft
Labeling option	identification label carrier

Transmission characteristics

Category (ISO)	6 _A
----------------	----------------

Connections/interfaces

Connector technology interface 1	M12-plug
Connector technology interface 2	free line end
Coding interface 1	X-coded
Number of positions/contacts interface 1	8
Termination data, stranded wire (min. - max.)	
Conductor cross section, stranded wire	AWG 26/7
Conductor diameter, stranded wire (bare copper)	0.48 mm
Conductor diameter, stranded wire (bare copper)	0.019 in.



P | Cabling

Data sheet

Page 3/7

M12 Industrial Ethernet cable, X-coded, 5.0 m, M12 plug angled - free line end, coding at 315°, PUR

P/N

142M2X90050

EAN 4250184174875

2022/03/16

Version: AR

Technical Data

Connections/interfaces

Cable sheath diameter (min. - max.)

Cable sheath diameter	6.4 mm
Cable sheath diameter	0.236 in.

Electrical characteristics

Current carrying capacity	0.5 A at 40 °C
Insulation resistance	min. 100 MOhm

Mechanical data

Bending radius without load	min. 64 mm
Maximum operating bending radius	64 mm
Maximum operating bending radius	2.52 in.
Maximum installation load	32 mm
Maximum installation load	1.26 in.
Shielding braid coverage	70 %

Materials and material properties

Material - Conductor	Cu (copper)
Material - Conductor Insulation	Polyethylene
Material - Cable jacket	PUR
Material - Body interface 1	Plastics
Material - Contact interface 1	CuZnPb (brass)
Material - Contact finish interface 1	Au (gold)
Material - Contact carriers interface 1	Plastics
Material - Union nut interface 1	CuZnPb (brass)
Material - Union nut finish interface 1	Ni (nickel)
Material - Pair shield	plastic film
Material - Pair shield finish	Al (Aluminium)
Material - Main shield	Cu (copper) braid
Material - Main shield finish	Sn (tin)
Flame retardancy	yes
Halogen free	yes
Silicone free	no paint wetting interfering substances (LaBS) in the process chain

P | Cabling

Data sheet

Page 4/7

M12 Industrial Ethernet cable, X-coded, 5.0 m, M12 plug angled - free line end, coding at 315°, PUR

P/N

142M2X90050

EAN 4250184174875

2022/03/16

Version: AR

Technical Data

Materials and material properties

LaBS Note	subsequent contamination possible due to handling and possible storage in your company
Oil resistance	yes
UV-resistance	yes
RoHS	compliant
REACH	compliant
REACH - substance (SVHC)	Lead / 7439-92-1

Environmental conditions

Temperature (min. - max.)	
Temperature - Operating °C	-30 °C - 90 °C
Temperature - Operating °F	-22 °F - 194 °F
Particulate ingress interface 1	IP6X when plugged in
Liquid ingress/immersion interface 1	IPX5, IPX7, IPX8 when plugged in
Pollution degree interface 1	3

Approvals

CE	compliant
UL listed (file no.)	Approval pending

Standards/Regulations

Generic cabling systems	
General requirements	ISO/IEC 11801-1 DIN EN 50173-1
PROFINET	yes
Connectors for electronic equipment	
Free and fixed connectors	IEC 60603-7-51
circular connector	DIN EN 61076-2-109
Multi-element metallic cables used in analogue and digital communication and control	DIN EN 50288-4-2
Test for vertical flame propagation for a single insulated wire or cable	IEC 60332-1-2
Measurement of smoke density of cables burning	IEC 61034
Determination of the halogen acid gas content	IEC 60754-1
Insulating and sheathing materials of cables and insulated wire - General test methods	DIN EN 60811-2-1
Copper and copper alloys - Drawn round copper wire for the production of electrical conductors	DIN EN 13602 Cu-ETP-A... DIN EN 13602 Cu-ETP-A...-B

P | Cabling

Data sheet

Page 5/7

**M12 Industrial Ethernet cable, X-coded, 5.0 m,
M12 plug angled - free line end, coding at 315°, PUR**

P/N

142M2X90050

EAN 4250184174875

2022/03/16

Version: AR

Technical Data

Classifications

ETIM 5.0	EC002599
ETIM 6.0	EC002599
ETIM 7.0	EC002599
ETIM 8.0	EC002599

Packing details

Type of packaging	1 pc(s) / plastic bag
-------------------	-----------------------

P | Cabling

Data sheet

Page 6/7

**M12 Industrial Ethernet cable, X-coded, 5.0 m,
M12 plug angled - free line end, coding at 315°, PUR**

P/N

142M2X90050

EAN 4250184174875

2022/03/16

Version: AR

Illustrations

Dimensional drawing

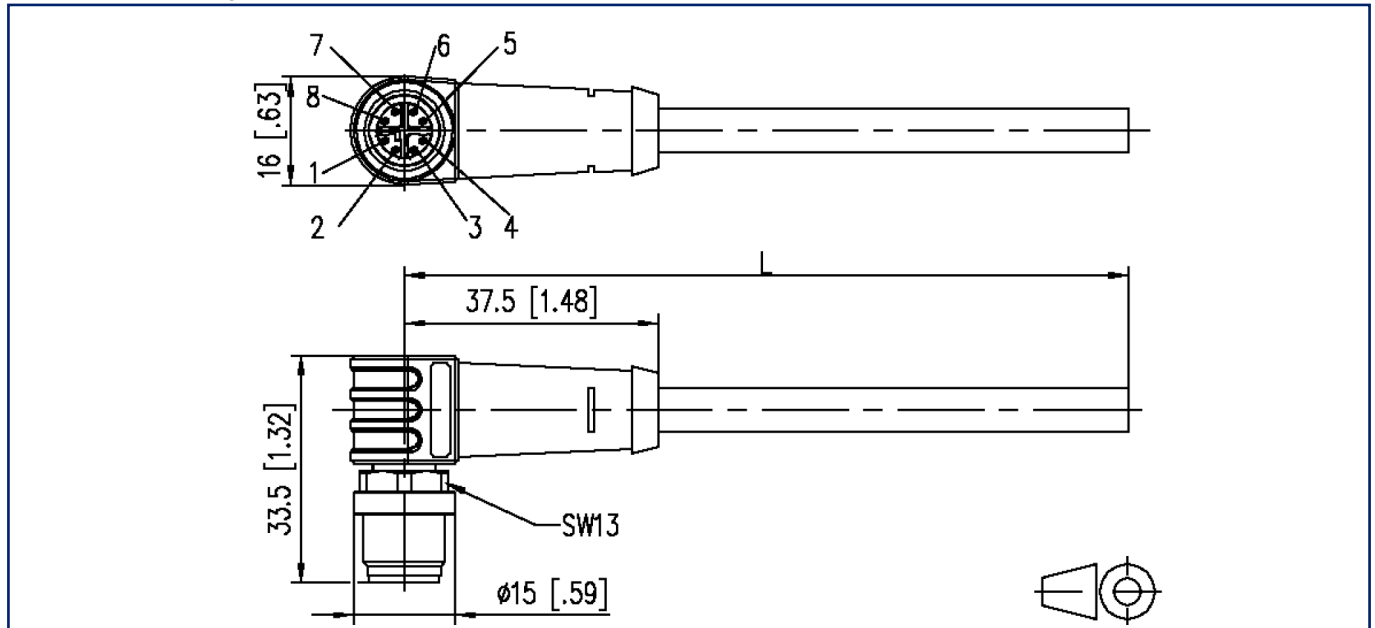

Wiring diagram

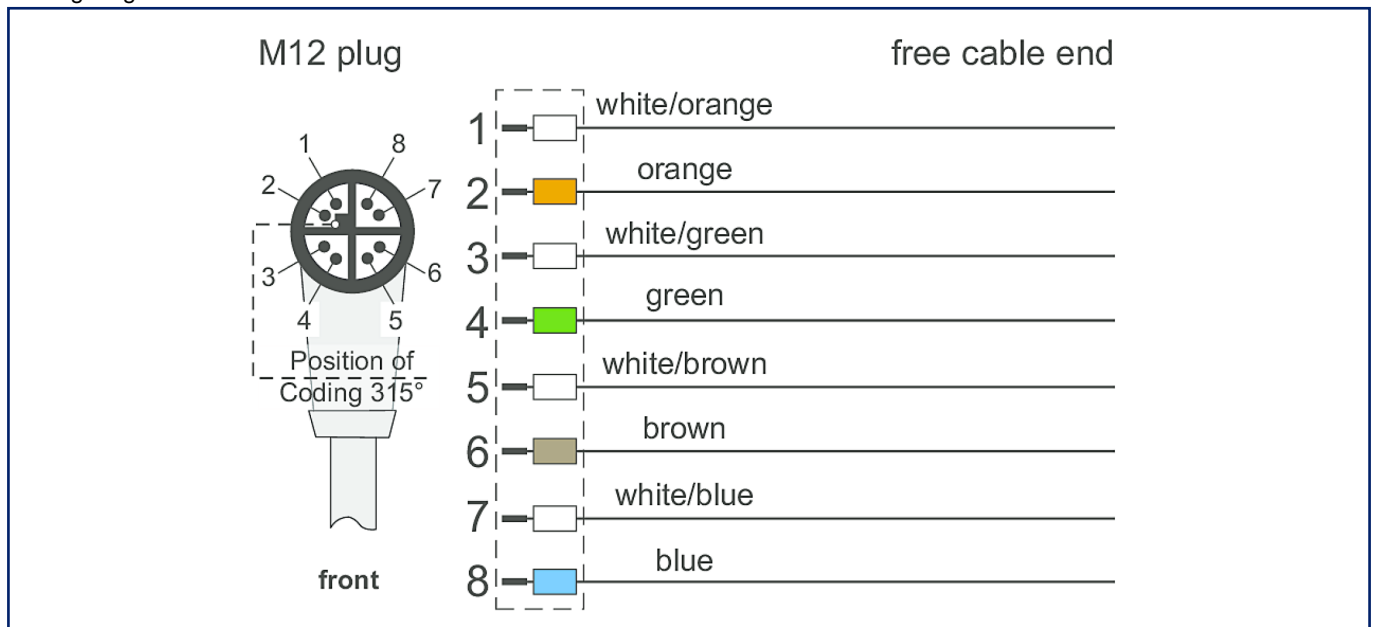

P | Cabling

Data sheet

Page 7/7

**M12 Industrial Ethernet cable, X-coded, 5.0 m,
M12 plug angled - free line end, coding at 315°, PUR**

P/N

142M2X90050

EAN 4250184174875

2022/03/16

Version: AR

Illustrations

Principle diagram



© 2022 METZ CONNECT - Technische Änderungen vorbehalten! Subject to modifications! Sous réserve de modifications techniques!

