

No.	Changes and/or Note No.	Date	Intr	No	Changes and/or Note No.	Date	Intr
-----	-------------------------	------	------	----	-------------------------	------	------

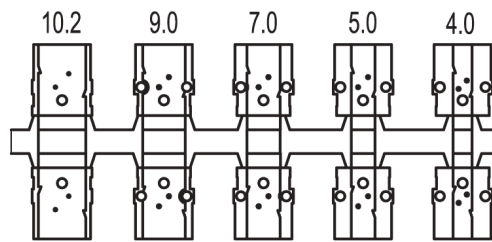
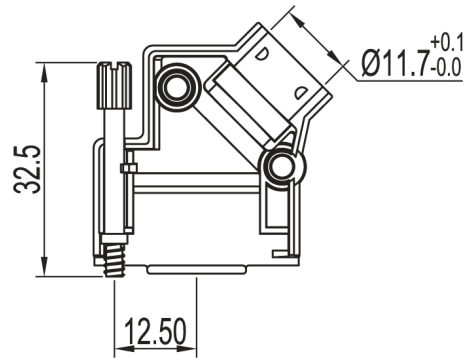
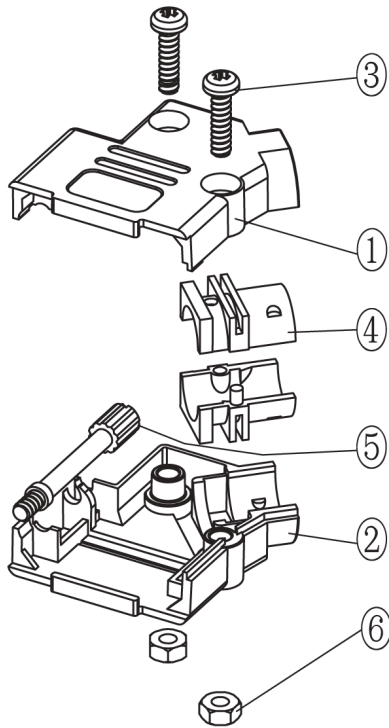
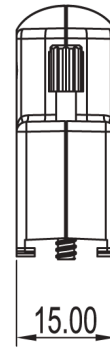
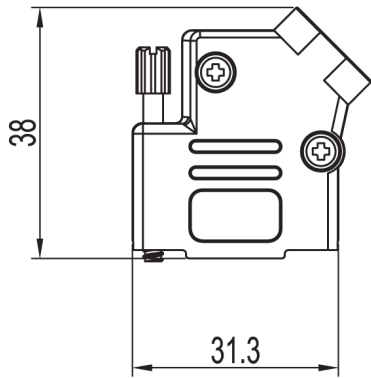

Grommet Set

Part Number:	Description:	Pack:	Item	QTY	Part description
6560-0146-11	D45PK-M-09-K	Kit	1	1	D45PK09-Upper cover
			2	1	D45PK09-Lower cover
6561-0146-11	D45PK-M-09	Bulk	3	2	M3X11.5 Screw
			4	1	D45ZK-D2 Grommet set
			5	1	UNC 4-40X32.5 Jackscrew
			6	2	M3 Nut

DATE: 2011-04-10	DRAWN: MRR	SCALE:	MATERIAL TYPE: Metalized	GENERAL TOLERANCES UNLESS OTHERWISE STATED LINEAR 0 ±0.20 0.0 ±0.15 0.00 ±0.10 ANGULAR ±0°30' ALL DIMENSIONS IN mm THIRD ANGLE PROJECTION
	APPROVED:		REPLACES:	