



Winkelstecker/-dose

nach MIL C-5015

Serie DMS

Fabrikat Fujikura DDK

Polzahlen: siehe u.a. Übersicht

Anzahl Baugrößen: 12

Anschlussart: Löten

Betriebstemperatur: -55 °C bis +125 °C

Material Gehäuse: zweiteilig, Aluminium, verzinkt, schwarz / vernickelt *

Material Kontakträger: Diallylphtalat (überwiegend kodierbar)

Material Kontakte: Kupfer, versilbert, Lötbereich vorverzinkt

Hinweis: Polbilder und elektrische Daten (siehe Datenblatt) / wasserdichte Ausführungen Serie DMS-F

Winkelstecker/-dose

Zugentlastung mit Gummitülle

Übersicht Polzahl in verfügbaren Baugrößen

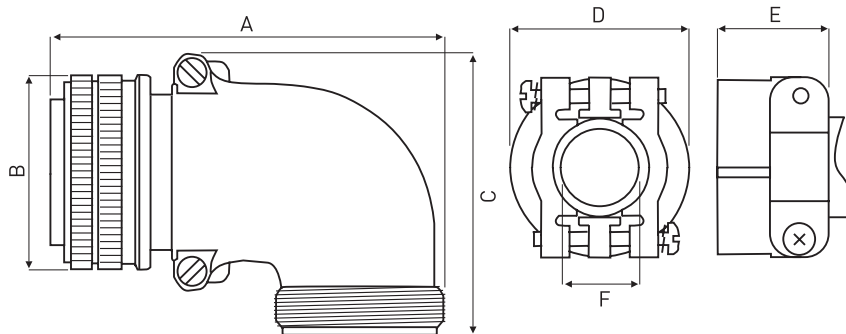

Polzahl	Baugrößen	Polzahl	Baugrößen
1	20	19	22
2	10SL, 12S, 14S, 20, 32	20	28
3	10SL, 14S, 16S, 16, 18, 22, 28, 36	22	28
4	14S, 18, 20, 22, 24, 32, 36	24	24
5	14S, 16S, 18, 32	26	28
6	14S, 18, 20, 36	30	32
7	16S, 20, 22, 24, 28	31	36
8	18, 20, 22	35	28, 32
9	20, 24	37	28
10	18	48	36
11	24	52	32
14	20, 22, 28, 32	54	32
16	24	73	36
17	20		

Baugröße	Winkelstecker *	Winkeldose *	Zugentlastung * mit Gummitülle	Abmessungen mm					
				A	B	C	D	E	F
12S	DMS 3108B 12S-XX P	DMS 3108B 12S-XX S	DMS 3057- 4AK	50,8	25,4	35,9	22,2	20,6	4,5-5,6
14S	DMS 3108B 14S-XX P	DMS 3108B 14S-XX S	DMS 3057- 6AK	54,0	28,6	41,9	27,0	22,2	5,5-7,0
16S	DMS 3108B 16S-XX P	DMS 3108B 16S-XX S	DMS 3057- 8AK	60,3	31,8	47,1	29,4	23,8	8,0-11,1
16	DMS 3108B 16-XX P	DMS 3108B 16-XX S	DMS 3057- 8AK	65,1	31,8	47,1	29,4	23,8	8,0-11,1
18	DMS 3108B 18-XX P	DMS 3108B 18-XX S	DMS 3057-10AK	68,3	34,1	50,7	31,8	23,8	9,0-14,3
20	DMS 3108B 20-XX P	DMS 3108B 20-XX S	DMS 3057-12AK	77,0	37,3	55,8	37,3	23,8	10,5-15,9
22	DMS 3108B 22-XX P	DMS 3108B 22-XX S	DMS 3057-12AK	77,0	40,5	57,4	37,3	23,8	10,5-15,9
24	DMS 3108B 24-XX P	DMS 3108B 24-XX S	DMS 3057-16AK	86,5	43,6	62,1	42,9	26,2	11,5-19,1
28	DMS 3108B 28-XX P	DMS 3108B 28-XX S	DMS 3057-16AK	86,5	50,0	65,3	42,9	26,2	11,5-19,1
32	DMS 3108B 32-XX P	DMS 3108B 32-XX S	DMS 3057-20AK	95,3	56,3	77,2	51,6	27,8	14,5-23,8
36	DMS 3108B 36-XX P	DMS 3108B 36-XX S	DMS 3057-24AK	100,0	62,7	85,2	57,9	29,4	21,5-31,8

Bitte Bestellnummer vervollständigen: XX = Polzahl (siehe obige Übersicht z.B. DMS 3108B 12S-)

* Bestellnummer Zusatz für vernickelte Ausführung: (D340) Winkelstecker/-dose / (D240) Zugentlastung

Polbilder / Baugrößen / elektrische Daten Polzahlen 10-19 Serie DMS / Fabrikat Fujikura DDK

Alle technischen Daten nach MIL C-5015

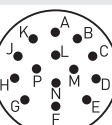
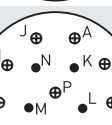
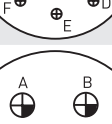
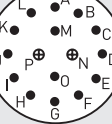
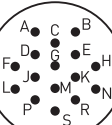
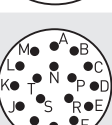
Polzahl	für Baugröße	Code für Polbild	Polbild (Steckseite Stift)	Kontaktgröße Crimpkontakt	für AWG	Strombelastung A	Spannung max. DC / AC V
10	18	18-1		16	22-16	13	200 / 250 (B, C, F, G = 500 / 700)
10	18	18-19		16	22-16	13	500 / 700
11	24	24-20		9x 16 2x 12	9x 22-16 2x 14-12	13 23	900 / 1.250
14	20	20-27		16	22-16	13	500 / 700
14	22	22-19		16	22-16	13	500 / 700
14	28	28-20		-	4x 22-16 10x 14-12	13 23	500 / 700
14	32	32-9		-	12x 22-16 2x 6-4	13 80	900 / 1.250
16	24	24-5		16	22-16	13	500 / 700
16	24	24-7		14x 16 2x 12	14x 22-16 2x 14-12	13 23	500 / 700
17	20	20-29		16	22-16	13	500 / 700
19	22	22-14		16	22-16	13	500 / 700

(Stand: 23.05.2019)